

# CTWatch QUARTERLY

ISSN 1555-9874

DOUBLE ISSUE

VOLUME 2 NUMBER 1

FEBRUARY 2006

## INTERNATIONAL CYBERINFRASTRUCTURE: ACTIVITIES AROUND THE GLOBE

GUEST EDITOR **RADHA NANDKUMAR**

### INTRODUCTION

#### 2 **International Cyberinfrastructure: Activities Around the Globe**

Thom Dunning, Director - NCSA; Professor and Distinguished Chair for Research Excellence - University of Illinois at Urbana-Champaign  
Radha Nandukumar, Senior Research Scientist, Program Director International Affiliations and Campus Relations - NCSA

### FEATURED ARTICLES

#### 5 **A National Grid Infrastructure for Australian Researchers**

John O'Callaghan, Australian Partnership for Advanced Computing

#### 10 **Cyberinfrastructure for Multidisciplinary Science in Brazil**

M A Raupp and B Schulze, National Laboratory for Scientific Computing  
M A Stanton and N Simoes da Silva, National Research and Education Network

#### 15 **GARUDA: India's National Grid Computing Initiative**

N. Mohan Ram, Chief Investigator - GARUDA  
S. Ramakrishnan, Director General - C-DAC

#### 20 **Cyber Science Infrastructure Initiative for Boosting Japan's Scientific Research**

Masao Sakauchi, Shigeki Yamada, Noboru Sonehara, Shigeo Urushidani, Jun Adachi, and Kazunobu Konishi, National Institute of Informatics (NII)  
Satoshi Matuoka, Tokyo Institute of Technology / NII

#### 27 **Construction and Utilization of the Cyberinfrastructure in Korea**

Hyeongwoo Park, Pillwoo Lee, Jongsuk Ruth Lee, Sungho Kim, Jaiseung Kwak, Kum Won Cho Sang-Beom Lim, and Jysoo Lee, KISTI Supercomputing Center, Korea

#### 32 **High Performance Computing in South Africa: Computing in Support of African Development**

Rob Adam, Director General's Office - Department of Science and Technology, Pretoria  
Cheryl de la Rey, Kevin J. Naidoo and Daya Reddy, University of Cape Town

#### 37 **Taiwan's Cyberinfrastructure for Knowledge Innovation**

Whey-Fone Tsai, Fang Pang Lin, Weicheng Huang Steven Shiau, Ming Hsiao Lee, Alex Wu, and John Clegg, National Center for High-Performance Computing, Taiwan

#### 43 **PRAGMA: Example of Grass-Roots Grid Promoting Collaborative e-Science Teams**

Peter Arzberger, UCSD  
Philip Papadopoulos, SDSC / UCSD

AVAILABLE ON-LINE AT

<http://www.ctwatch.org/quarterly/>

Cyberinfrastructure Technology Watch

<http://www.ctwatch.org/>



# International Cyberinfrastructure: Activities Around the Globe

## Introduction

Cyberinfrastructure is now essential for advancing scientific discovery and the state-of-the-art in engineering. It doesn't matter whether it's the inner workings of the universe or the inner workings of the economy, the design of a new chemical process or the design of a new material, new insights into how cells function or the delivery of personalized medicine, the spawning of a tornado or planning urban development. The basic fact remains the same—cyberinfrastructure is now a driver of science and engineering. Without it, science and engineering will not reach their full potential.

But, science and engineering is a global activity. There is not an American chemistry and a French chemistry, nor is there a Japanese electrical engineering and a Brazilian electrical engineering. Scientists and engineers around the globe are focused on unraveling the secrets of nature and applying this hard gained knowledge to the betterment of humanity. Cyberinfrastructure must support this global activity. In fact, it is our belief that cyberinfrastructure, properly designed and constructed, will advance science and engineering as a global activity by facilitating access to resources and expertise wherever they are located.

There are three intertwined strands of a global infrastructure:

*Cyberenvironments*: to provide researchers with the ability to access, integrate, automate, and manage complex, collaborative projects across disciplinary as well as geographical boundaries.

*Cyber-resources*: to ensure that the most demanding scientific and engineering problems can be solved and that the solutions are obtained in a timely manner.

*Cybereducation*: to ensure that the benefits of the national cyberinfrastructure are made available to educators and students throughout the country and the world.

NSF's latest version of "Cyberinfrastructure Vision for 21st Century Discovery" was released on January 20, 2006. One of the guiding principles in this vision is "national and international partnerships, public and private, that integrate CI users and providers and benefit NSF's research and education communities are ... essential for enabling next-generation science and engineering."<sup>1</sup>

During his keynote address<sup>2</sup> at NCSA's 20th Anniversary Celebration in January 2006 entitled, "Un-common sense: A recipe for a cyber planet," Dr. Arden Bement, Director of the National Science Foundation, remarked that "cyberinfrastructure will take research and education to a new plane of discovery. It is critical for advancing knowledge in the face of a dynamic and changing global technological environment." In discussing issues related to global competition and sustaining the long history of technological leadership that the US has enjoyed, Dr. Bement provided some uncommon-sense advice: "We should pursue more global involvement, not less. The rapid spread of computers and information tools compels us to join hands across borders and disciplines if we want to stay in the race."

## Thom Dunning

Director, National Center for  
Supercomputing Applications

Professor and Distinguished Chair for  
Research Excellence, Department of  
Chemistry, University of Illinois at Urbana-  
Champaign

## Radha Nandkumar

Senior Research Scientist  
Program Director, International Affiliations  
and Campus Relations, National Center for  
Supercomputing Applications

<sup>1</sup> [http://www.nsf.gov/od/oci/ci\\_v5.pdf](http://www.nsf.gov/od/oci/ci_v5.pdf)

<sup>2</sup> [http://access.ncsa.uiuc.edu/Releases/01.27.06\\_NCSA\\_dedic.html](http://access.ncsa.uiuc.edu/Releases/01.27.06_NCSA_dedic.html)

For this issue of *CTWatch Quarterly*, we invited articles from several key influential trend-setters across the globe and asked them to provide their vision for cyberinfrastructure in their respective environs and for extending them in an international context. (The November 2005 issue of *CTWatch Quarterly*<sup>3</sup> focused on cyberinfrastructure in Europe.)

<sup>3</sup> <http://www.ctwatch.org/quarterly/archives/november-2005>

There are eight articles describing activities in Australia, Brazil, India, Japan, Korea, South Africa, Taiwan, and the Pacific Rim Applications and Grid Middleware Assembly (PRAGMA).

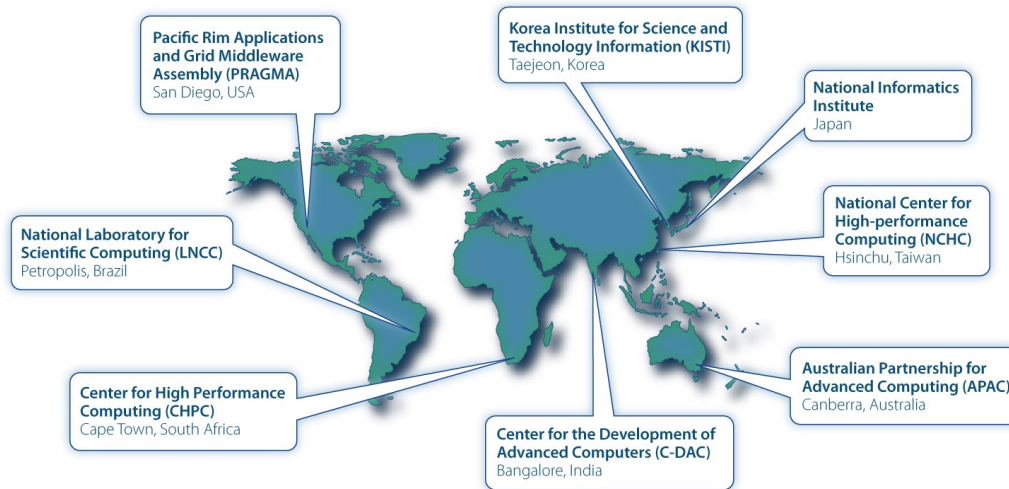

Figure 1. The global list of contributions to this issue

- The Australian Partnership for Advanced Computing (APAC) leads the Australian National Grid Program. John O’Callaghan describes the APAC and its vision for providing advanced computing, information and grid infrastructure for the Australian research community through the APAC National Grid Program. This program encompasses the national facilities at APAC and the distributed partner sites, supporting distributed research on national and international levels. As you will read, the advanced communication infrastructure that is in place in Australia offers many opportunities for international collaborations.
- Brazilian efforts are described by Marco Raupp *et al.* in “Cyberinfrastructure supporting multidisciplinary science in Brazil.” The authors provide a short history of the high-end computing and the national networking infrastructures, discuss the recent upgrades and the current environment that exists, highlight activities in the development of cyberenvironments, and touch upon some critical applications.
- India’s emerging nation-wide computational grid “GARUDA,” which aims to aggregate distributed resources of research and academic institutions, is described by Mohan Ram and S. Ramakrishnan. The article describes the architecture and the major components of GARUDA—the grid resources, network, middleware, data management, and portals. The authors also point to a couple of sample applications of national importance in India—sensor networks and bioinformatics—that will be tackled using this infrastructure.
- Japan’s Cyber Science Infrastructure (CSI)—the next generation academic information environment, coordinated by the National Institute of Informatics in collaboration with Japanese universities and academic institutions—is described by Masao Sakauchi *et al.* They describe

---

## International Cyberinfrastructure: Activities Around the Globe

Japan's academic networking and National Research Grid Initiative (NAREGI) as well as the provision of academic digital content for CSI.

- Korea's effort in the construction and utilization of cyberinfrastructure and its current status is described by Hyeonwoo Park *et al.* The phenomenal strides in broadband deployment and adoption in Korea and the advantages it provides for establishing a grid infrastructure, supporting middleware development, and for undertaking cutting-edge research in grids are described. The authors also discuss some sample e-Science projects.
- South Africa's article, "HPC in South Africa: Computing is support of African Development" by Rob Adam *et al.*, describes the objectives and structure of the Center for High Performance Computing (CHPC) as an arm of the Meraka Institute that facilitates needs-based research and innovation. They discuss current progress in the establishment of CHPC, and its implications for linking research and innovation in addressing the needs of the South African society and economy with further reach into the continent of Africa and the world.
- "The Taiwan Cyberinfrastructure for Knowledge Innovation" article by Whey-Fone Tsai *et al.* addresses how Taiwan's twin projects, Knowledge Innovation National Grid (KING) and Advanced Research and Education Network (TWAREN), form the kernel of Taiwan's cyberinfrastructure and enable science and engineering innovation. The authors describe their development and deployment efforts in the various components of the cyberinfrastructure and in enabling grid applications in sensor networks and in ecological and environmental domains as well as community health.
- Last but not least, in "PRAGMA: Example of Grass-Roots Grid Promoting Collaborative e-Science Teams," Peter Arzberger and Phil Papadopoulos outline the unique membership-partnership activities under the auspices of PRAGMA – the Pacific Rim Applications and Grid Middleware Assembly. They illustrate the potential of bringing resources, tools and research teams from around the world to create, support and sustain international science and technology collaboration, and the challenges associated with making this a reality on a routine basis. PRIME and PRIUS are some of the major activities spearheaded by PRAGMA that involve the next generation of students.

Enabling innovation and breakthrough science seem to be unifying themes across all institutions. Applications with a broader societal impact—health and human life, drug design and discovery, bioinformatics, weather forecasting, climate change, environmental modeling, disaster management and mitigation, natural language processing, collecting, analyzing, mining and visualizing large volumes of data, and so on—are where most of the demands and interest in the development and establishment of cyberinfrastructure rest.

The world's treasure is its people. Together, we can do ordinary things in extraordinary ways and can make the whole greater than the sum of the parts. All of the articles in this issue of *CTWatch Quarterly* are a testament to the extraordinary opportunities that exist for global collaborations and for joining together in addressing frontier research problems in science and engineering, problems that will have long-term societal impacts. Working together, we can truly create a cyberinfrastructure that will emphasize that "we are in one world" and "it is a small world."

Please read on.

---



# A National Grid Infrastructure for Australian Researchers

## 1. Introduction to APAC

John O'Callaghan

Australian Partnership for Advanced Computing

The Australian Partnership for Advanced Computing (APAC) was established by the Australian Government to strengthen the advanced computing capabilities in Australia.

It is now a national partnership of eight organisations, one in each State as well as ANU<sup>1</sup> and CSIRO<sup>2</sup>. The State-based partners are joint ventures involving most of the Australian Universities and have received strong support from the State Governments and their members. All eight APAC partner organizations are listed at the end of the article.

<sup>1</sup> [http://www.dest.gov.au/sectors/research\\_sector/policies\\_issues\\_reviews/key\\_issues/ncris](http://www.dest.gov.au/sectors/research_sector/policies_issues_reviews/key_issues/ncris)

<sup>2</sup> <http://www.apac.edu.au/>

APAC established the APAC National Facility in 2001 to provide a world-class peak computing facility for Australian researchers in higher education institutions. It also initiated programs to significantly increase the expertise and skills in partner organisations to support users of advanced computing systems.

In recent years, the Federal Government has supported APAC broadening its role to provide an advanced computing, information and grid infrastructure for the Australian research community. The APAC National Grid is allowing researchers to access distributed computation and information facilities as a single virtual system and is providing a new range of services to support research collaboration, nationally and internationally.

APAC's vision is for Australian research teams to have seamless access to distributed computation and information facilities as part of the global research infrastructure. This vision is aligned with recent Government and institutional initiatives that focus on eResearch. For example, the Australian Government has established a National Collaborative Research Infrastructure Strategy (NCRIS)<sup>1</sup>, which provides a coordinated approach to the deployment and support of Australia's research infrastructure.

This paper outlines the concept and activities of the APAC National Grid. More information on APAC can be found at its website<sup>2</sup>.

## 2. The Concept of the APAC National Grid

The APAC National Facility which is hosted at the ANU provides advanced computing services and specialist support to over 750 users around Australia<sup>3</sup>. Most of these users are allocated resources by 'merit-based' granting schemes.

<sup>3</sup> <http://www.nationalfacility.apac.edu.au/>

The peak system at the National Facility is an SGI Altix 3700 Bx2 cluster with 1680 processors - it was ranked number 35 in the Top500 list of November 2005. The facility also houses a mass data storage system based on Sun servers running SAM-QFS and a Storagetek tape silo with petabyte capacity. The system supports a number of 'data intensive' projects including some in linguistics and the social sciences.

In addition to this facility, the partners manage separate facilities and play a vital role in developing Australia's capability in advanced computing, information and grid infrastructure.

## A National Grid Infrastructure for Australian Researchers

They provide operational advanced computing services to their users and are involved in research, development, education, training and outreach activities.

The aim of the APAC National Grid is to allow research teams to easily access the resources at the National Facility and the partner facilities as a single virtual system. These resources include

- A variety of computing systems with a diverse range of applications software
- Large-scale data storage systems providing services for information management and access
- Portals and associated services to access the resources
- Collaborative work environments including access grid rooms at each partner site and a range of visualisation and virtual reality facilities.

The APAC National Grid therefore provides a variety of resources to support distributed research teams in an operational (or 'production level' environment).

The design of the National Grid incorporates open interfaces to other resources such as institutional computing systems, on-line instruments, sensors and other data sources. It is also developing interfaces that will allow inter-operation with other grids at the institutional, national and international levels. The design aims to allow researchers to see the resources in the APAC National Grid as an extension of their personal work environments. In this sense, the National Grid is an infrastructure that is transparent to most of its users.

The concept of the National Grid as an integrated virtual system with interfaces to external systems and grids as illustrated in Figure 1. below. The resources of the APAC National Facility and the partner facilities are included in the cloud, unified through a common security system and portals to access the resources.

Most of the users of the National Grid will be the current users of the individual systems. The National Grid offers them an easier way to access multiple resources provided by APAC and its partners. As a result, the extent of the resources in the National Grid is being determined by those users that want to access resources through the National Grid interface mechanisms (portals, authentication, authorization). This approach avoids the need for partners to pre-determine a percentage of the resources to be allocated to users of the National Grid. In addition, the current processes to determine the resources provided to users can be continued.

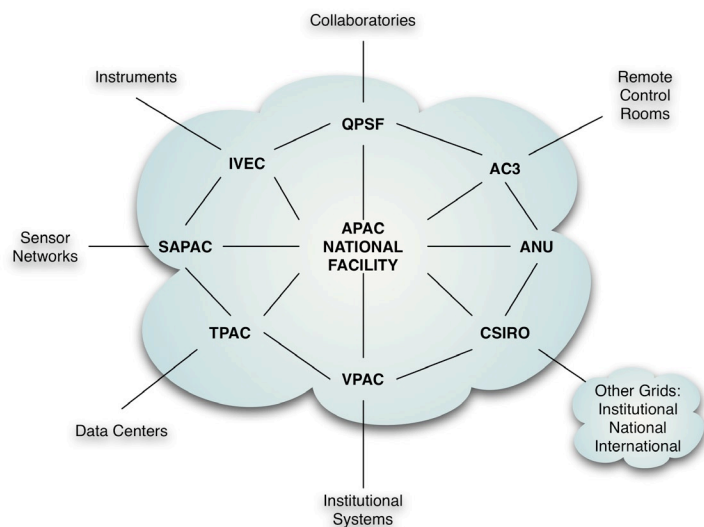

Figure 1. Conceptual diagram of the National Grid as an integrated virtual system

The policies and agreements between the partners to support this approach are based on existing agreements that have been developed elsewhere for production grids. More effort is required to determine the agreements for external organizations in order to interface their systems to the National Grid. This will require an understanding of the services that these organizations demand from the National Grid.

### 3. The APAC National Grid Program

The APAC National Grid is being built through a program involving over 120 professionals in 24 organisations, with an effective full-time effort of around 50 people. The program is currently in a development phase, with an operational phase starting in early 2007.

The program consists of two kinds of projects that collectively are developing the National Grid infrastructure and delivering services to users. The application support projects involve working with specific research teams in the following areas: astronomy, high-energy physics, chemistry, bioinformatics, earth systems science and geosciences. Table 1 lists the projects and their aims.

<b>Virtual Observatory Data Warehousing</b>
Efficient, standardised access to key Australian and international astronomical data collections within the Australian Virtual Observatory (Aus-VO).
<b>Gravity Wave Research</b>
Access to Australian computing and storage resources, along with environmental and interferometer detection equipment, and interfacing this grid infrastructure with those of international collaborators.
<b>Virtual Observatory Theory Portals</b>
Services for job configuration, job submission to available grids, and subsequent monitoring for a wide range of theoretical astrophysics codes with access to the Aus-VO.
<b>Belle and ATLAS Experiments</b>
On-line access to the Belle data (10 TBytes per year) produced by the KEK laboratory in Japan through a federation of SRB databases. Deployment of the LHC Computing Grid (LCG-2) toolkit to support implementation tests and physics simulations as part of the Atlas project.
<b>International Lattice Data Grid</b>
Implement a node of the International Lattice Data Grid (ILDG) in Australia to locate and access expensive lattice simulation data.
<b>Computational Chemistry</b>
A uniform web-based interface to computational molecular science codes allowing data exchange between different codes and unified operations on a set of molecules.
<b>Genome Annotation</b>
A distributed Genome Annotation System (using the Rice Genome as a model) involving a local Ensembl database and a grid-enabled Blast system.
<b>Molecular Docking</b>
A portal for molecular docking applications using a wide variety of chemical databases, with interfaces for automated analysis, visualization and storage of virtual screening results.
<b>Earth Systems</b>
Access to Australian data sets related to oceans, atmospheres, Antarctica and climate change using OpenDAP protocols and to computational models producing global data sets of land surface fluxes, state variables and related hydrologic quantities.
<b>Geoscience Modelling</b>
A workflow service to support mantle convection modeling accessing using open standards (based on XML) to access geological and geophysical data.
<b>Earthbytes</b>
Visualization and simulation of tectonic plate movements based on geological and geophysical observations.

Table 1. Application Support Projects in the APAC Grid Program

## A National Grid Infrastructure for Australian Researchers

The infrastructure projects are developing and providing services to satisfy the requirements of the applications. These projects cover the areas of computing infrastructure, information infrastructure, user interfaces and visualisation infrastructure and collaboration infrastructure.

The core grid middleware for the National Grid is the Virtual Data Toolkit (VDT) being used in the Open Science Grid and deployed on Globus Toolkit (Version 2). This is being complemented with toolkits for virtual organisation management, resource discovery, job scheduling and job monitoring.

An APAC Certificate Authority (CA) has been established to provide an authentication service for users of the National Grid. The CA has recently been recognised as a production level service by the Asia-Pacific Grid Policy Management Authority (APGridPMA). This allows APAC certificates to be acknowledged by other grids around the world and therefore support international research collaboration.

The design of the National Grid involves a 'gateway' system at each partner site configured to support a range of grid services and to receive and process grid service requests. The aim of the design is to:

- limit the number of systems that need grid components installed and managed within the APAC partnership thus reducing overall grid management overheads
- enhance security as many grid protocols and associated ports only need to be open between the gatekeepers, as only the local gatekeeper needs to interact with site systems
- support roll-out and control of production grid configuration through the implementation of standardised grid support across all APAC partner sites
- support production and development grids and local experimentation without significant hardware investment through a Virtual Machine implementation where different services and different quality of services are provided on separate grid installations

Through the use of a 'virtual machine' tool, the gateways are supporting the following production and development grids simultaneously:

Virtual Machine 1	VDT based on Globus 2 (ng1)
Virtual Machine 2	VDT based on Globus 4 (ng2)
Virtual Machine 3	SRB services (ngdata)
Virtual Machine 4	Production portals
Virtual Machine 5	Development server (ngdev)
Virtual Machine 6	LCG grid

The architecture of the gateway system at one of the APAC partners (VPAC) is shown in Figure 2. The gateway system is connected to the external networks (GrangeNet and AARNet) and internally to the compute systems (Edda, Brecca, Wexstan) as well as the data control network. The scheduling of jobs on the compute systems is done through a version of PBS.

The information infrastructure is providing a variety of tools for autonomous data movement, replication and optimised access,

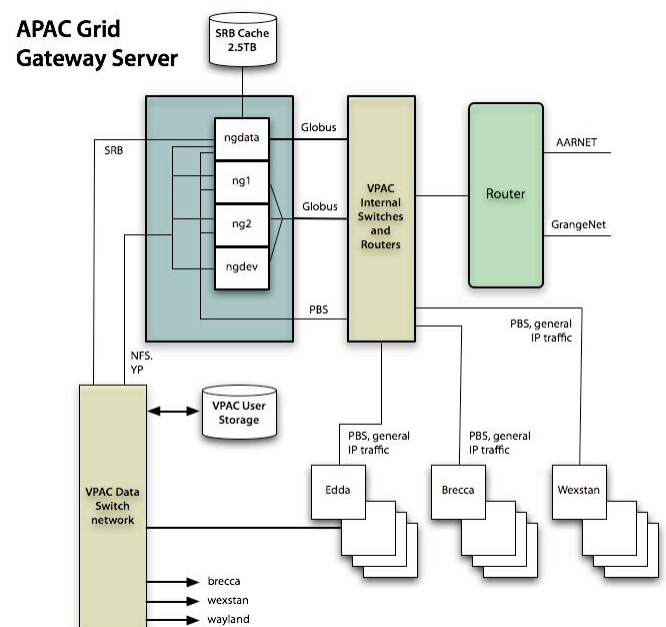

Figure 2. Architecture of an existing APAC partner gateway system



data virtualisation and metadata support. An SRB federation has been implemented to support access to distributed data sets.

Portals for applications to access the National Grid are being developed using the GridSphere toolkit. Generic portlets have been developed for common procedures such as authentication, file transfer and job submission. Plans are being developed to provide a rendering engine for visualization and supporting simultaneous viewing across multiple sites.

Australian researchers have access to a number of Access Grid nodes and considerable effort has been contributed by the APAC partners and other groups to improve the robustness, management, usability and accessibility of these facilities. This effort is being extended in the APAC Grid program to enable these nodes to be used as instrument control rooms, distributed visualisation facilities and collaborative work environments.

Plans are being developed for the APAC partners to be connected by a high-speed private network. Currently most the partners are connected by the GrangeNet experimental network<sup>4</sup>. This will be replaced by a network configured on the new national backbone network being installed by AARNet<sup>5</sup>.

<sup>4</sup> <http://www.grangenet.net/>

<sup>5</sup> <http://www.aarnet.edu.au/>

#### 4. The APAC National Grid in the International Context

APAC is participating in discussions with other 'production grid' organisations on the development of inter-operable grids. This will enable Australian researchers to collaborate using computing and information facilities around the world. Examples of collaboration are in accessing astronomical data sets, very long baseline interferometry, Belle and Atlas experiments, lattice data grids, and climate change modelling.

Such international collaboration is being underpinned by an advanced communications infrastructure involving a trans-Pacific gigabit research link provided by AARNet.

APAC is also participating in a number of international programs to promote the development and use of grid infrastructure. APAC is a Founding Institutional Member of PRAGMA which fosters cooperation on grid infrastructure and applications by Pacific Rim organisations. APAC is also a Silver Sponsor of the Global Grid Forum.

---

#### The APAC Partners

Australian Centre for Advanced Computing and Communications (ac3): <http://www.ac3.com.au>

Commonwealth Scientific and Industrial Research Organisation (CSIRO): <http://www.hpsc.csiro.au>

The Hub of Advanced Computing in Western Australia (iVEC): <http://www.ivec.org>

Queensland Parallel Supercomputing Foundation (QPSF): <http://www.qpsf.edu.au>

South Australian Partnership for Advanced Computing (SAPAC): <http://www.sapac.edu.au>

The Australian National University (ANU): <http://www.anusf.anu.edu.au>

University of Tasmania acting as host for the Tasmanian Partnership for Advanced Computing (TPAC): <http://www.antcrc.utas.edu.au/tpac>

Victorian Partnership for Advanced Computing (VPAC): <http://www.vpac.org>

# Cyberinfrastructure for Multidisciplinary Science in Brazil

## Introduction

Long-distance, high-speed and low-cost networking has encouraged the development of applications taking advantage of geographically distributed resources, opening up new research directions that were previously limited or unexplored for economic and practical reasons. The establishment of Cyberinfrastructure allows mature, scalable computing for different application communities.

Grid initiatives in Brazil were initially driven by international collaborations in several application areas and the pursuit of higher network bandwidth and larger computational facilities. In response to this demand, the National Laboratory for Scientific Computing - LNCC headed a proposal formulated together with representatives of application groups, computer and computational science, computer networking, high-performance computing, and federal government funding agencies belonging to the Ministry of Science and Technology (MCT). This early proposal was based on a number of existing international initiatives and focused on improving connectivity and communication performance for the coordinated use of existing regional HPC centers, as well as a number of academic and research institutions as potential users. At this time there were seven regional HPC centers and nine academic and research institutions involved, with connectivity provided by the Brazilian National Research and Education Network - RNP, and funding by the MCT funding agencies. The application areas included high-energy physics, bioinformatics, climate and weather forecasting and oil industry needs, among others.

In 2003, the legal framework was established for a National System for HPC (SINAPAD) with LNCC being designated the national coordinator (on behalf of MCT), and was recognized as part of the Federal Education, Science & Technology infrastructure. SINAPAD consisted of a network of regionally distributed, operational HPC centers aimed at providing computation on demand for education and scientific purposes, with a proposed operational structure based on mid-sized computer systems and clusters organized into a grid for the sharing of resources and reduction of idle time. Clusters of a few hundred processors were planned for each center, combining distributed and shared memory machines, facilities for data storage and handling, user friendly access through a web portal, security, accounting, and the option of several alternative architectures.

## HPC and Networking History

Brazil has a territorial extent of about 8.5 million km<sup>2</sup>, making it the fourth largest country in the world, with correspondingly large demands in order to reach all parts of the country. The federal constitutional order is similar to the USA, with 26 states and a Federal District around the national capital, Brasília. The history of academic HPC in Brazil began in 1990, based on the concept of government-funded regional centers open to universities and research institutes, as in Table 1, with seven such centers being established between 1992 and 1997. INPE formally joined the system only in 2002, contributing with its former production machine formerly dedicated to environmental sciences.

Internet technology had already been brought to Brazil by concerted initiatives by state governments in a number of the more populous states, such as São Paulo, Rio de Janeiro and

Marco A Raupp

Bruno Schulze

National Laboratory for Scientific Computing,  
LNCC

Michael Stanton

Nelson Simões

National Research and Education Network,  
RNP

---

Rio Grande do Sul, coordinated nationally by the federal government through RNP. The first national IP backbone network in Brazil was launched by RNP in 1992 to serve the national academic and research community, and connected 11 cities<sup>1</sup>. Since 1992, the national network run by RNP has evolved through four significant increases in capacity and usually also technology, where the fourth such change was initiated in November, 2005. Table 2 summarizes these changes. It is relevant to discuss here the Project GIGA testbed network (2004-) and the most recent national network upgrade initiated in 2005.

Center		Comment
LNCC	National Laboratory for Scientific Computing	initially IBM SP2, later upgraded with SUN and SGI machines
UFRGS	Federal University of Rio Grande do Sul	initially Cray XMP and later upgraded to a Cray T90
UNICAMP	State University of Campinas	initially IBM SP2, later upgraded with SUN machines
UFMG	Federal University of Minas Gerais	initially IBM SP2, later upgraded with SUN machines
UFRJ	Federal University of Rio de Janeiro	initially CRAY, recently upgraded with SGI Altix machines
UFC	Federal University of Ceara	
INPE/CPTEC	National Space Research Institute/Climate and Weather Forecasting Center	initially NEC SX 4, later upgraded to a SX 6

Table 1. SINAPAD centers

Year	Technology	Link capacities	Comment
2005	IP/WDM	2.5 and 10 Gbps	IPÉ network core to 10 capitals; metro networks in 27 capitals
2003	IP/SDH	34, 155, 622 Mbps	also: IP/WDM interstate gigabit testbed network (GIGA)
1999	IP/ATM, IP/FR	VC < 45 Mbps, access < 155 Mbps	RNP2 national network; testbed metro networks in 14 cities (ATM)
1995		< 2 Mbps	also: commercial IP deployed in Brazil
1992	Internet	9.6 and 64 kbps	first IP network (RNP)

Table 2. Evolution of academic networking in Brazil

## Cyberinfrastructure Networking

With the objective of developing and deploying new optical networking technologies, CPqD<sup>2</sup> and RNP formed a partnership to build an optical testbed network, connecting seven cities in the adjoining states of Rio de Janeiro and São Paulo. This project, named GIGA<sup>3</sup>, has been supported financially since December 2002 by the federal government's Fund for the Development of Telecommunications Technology (FUNTTEL) and has resulted in building a 700 km network using dark fiber provided without cost by four telcos and lit up using WDM optical equipment produced by PADTEC, a spin-off of CPqD. This network provides IP service over Gigabit Ethernet to end users in 17 research institutions and four telcos in seven cities (see Figure 1). Most users are R&D groups developing subprojects of Project GIGA, under contract to CPqD or RNP. For RNP, the establishment of this optical networking testbed was the first step in implementing its long-term strategy, known as the National Optical Initiative (ION), which emphasizes the provision of future networking services to end-users through a "facilities-based" infrastructure, such as dark fiber or WDM waves, rather than one based on renting telco-provided services, such as ATM or SDH/Sonet.

The testbed network built by Project GIGA has provided extensive hands-on experience in the design, deployment and operation of both metropolitan and long-distance optical networks,

<sup>1</sup> Stanton, M.A., Ribeiro Filho, J.L., Simões da Silva, N. "Building Optical Networks for the Higher Education and Research Community in Brazil", COMNETS2005, Oct. 2005.

<sup>2</sup> R&D center of the then former telecommunications monopoly - <http://www.cpqd.com.br/>

<sup>3</sup> Scarabucci, R.R., Stanton, M.A. et al., Project GIGA - High-speed Experimental Network. TRIDENTCOM'05, p. 242-251, Feb. 2005.

## Cyberinfrastructure for Multidisciplinary Science in Brazil

and thus has served as a basis for future development of networks to serve the wider research and higher education community. Within RNP, forward network planning has been heavily influenced by the experience gained in Project GIGA, particularly related to identifying and serving particular user groups, and also as regards the technologies employed. Attention has also been given to new directions in networking adopted in other countries during the last five years, highlighted by such initiatives as National Lambda Rail<sup>4</sup>, CANet4<sup>5</sup> and SURFnet6<sup>6</sup>, among others, and widely reviewed in the excellent series of reports produced by the European SERENATE study<sup>7</sup>. It was decided that RNP should accompany the global tendency to increase the link capacities of its national network to multiple Gbps. This was in fact undertaken in November, 2005, but was preceded by a migration to SDH/Sonet links starting in 2003, with the abandonment of ATM and Frame Relay (FR) as link technologies. The fact that this first migration could be achieved with an increase in aggregate link bandwidth of around six times (from 350 Mbps in 2003 to over 2 Gbps in 2005) with a 30% reduction in cost is a reflection of a combination of newer technologies and the introduction of competition in the telecommunications marketplace.

In 2005, RNP moved onto the next stage of its ION strategy, replacing the links between the 10 principal cities of its national network by a solution in the form of unprotected, transparent lambdas (waves) of 2.5 and 10 Gbps. The core of what is now known as the IPÊ<sup>8</sup> network (see Figure 2) was commissioned in November. The increase in aggregate link bandwidth for this IPÊ network core is from around 1.6 Gbps (SDH) to 60 Gbps (waves), or almost 40 times, at only three times the cost! In fact, the overall cost of the whole national network is now just 30% more than in 2003, for an increase in aggregate bandwidth of almost 180 times. As an essential complement to the deployment of the IPÊ network, RNP is also engaged in a nationwide project, known as Community Networks for Education and Research (Redecomep), to deploy optical metropolitan area networks in all 27 capital cities by December 2006. These networks are designed to provide gigabit access to the RNP point of presence (PoP), as well as interconnecting all the campi of RNP clients in these metro areas<sup>1</sup>. International connectivity for RNP's IPÊ network is based on links to commodity networks and also research and education connections (RE) directly connecting to other RE networks (REN), such as CLARA (the regional Latin American REN), Abilene (US NREN), CalREN (California REN), Géant (European REN), among others. A summary of these is shown in Table 3.

<sup>4</sup> NLR, "About National LambdaRail" - <http://www.nlr.net/about.html/>

<sup>5</sup> CANARIE, "About CA\*net4" - <http://www.canarie.ca/canet4/>

<sup>6</sup> SURFnet, "Network" - <http://www.surfnet.nl/info/en/network/home.jsp>

<sup>7</sup> Study into the evolution of European Research and Education Networking - <http://www.serenate.org/>

<sup>8</sup> Ipê is Brazil's national flower, and pronounced in Portuguese as the abbreviation IP (Internet Protocol).



Figure 1. Location of the Project GIGA testbed network (2004)

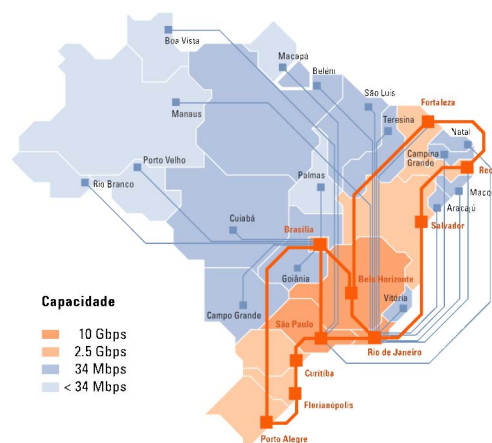

Figure 2. IPÊ network in 4Q2005



Type	Comment
Commodity	310 Mbps from Rio de Janeiro and 45 Mbps from S. Paulo via Global Crossing
RE	155 Mbps (with possible temporary extensions to up to 622 Mbps) from São Paulo via CLARA network, which connects to most other national RENS in Latin America at up to 155 Mbps, to Géant at 622 Mbps through a São Paulo-Madrid link, and to CalREN at 1 Gbps through a Tijuana (México)-San Diego link. The CLARA network was built through the European Union's ALICE project <sup>9</sup> .
RE	To the USA through a S. Paulo-Miami link with 1.2 Gbps bandwidth, shared with the São Paulo state network (ANSP), as from January 2006 (This link, like the Tijuana-San Diego link, are provided through the WHREN/LILA project <sup>10</sup> of NSF's International Research Networks Connections (IRNC) program).

Table 3. International connections available to RNP's IPÊ network

## Activities in Cyberenvironments

At LNCC, early grid-related research and development activities started within Project ComCiDis (Distributed Scientific Computing) in 2002, with the purpose of providing guidelines and directions to the SINAPAD initiative, as well as to establish and strengthen national and international collaborations.

The research program of Project GIGA coordinated by RNP includes the thematic area of Large-Scale Distributed Applications, initially with twelve supported subprojects, allowing for the development and maturing of such technology between high-speed interconnected partners, targeting grid middleware and also some applications. The testbed traffic is restricted to supported subprojects. We focus on two of these subprojects, InteGridade<sup>11</sup> and Sinergia, where NCSA<sup>12</sup> participates as an international collaborator on cyberinfrastructures and cyberenvironments. These two subprojects are actually conducted as a single project, involving five with testbed access, and two more connected via Internet only. The institutions involved are: LNCC - ComCiDis (Distributed Scientific Computing Group), UFF - Institute of Computing, CBPF<sup>13</sup>, UNICAMP - Institute of Computing, PUC-Rio<sup>14</sup> - Parallelism Lab, and UFRGS - Institute of Informatics, and UFES<sup>15</sup> - Dept. of Informatics. We also count on RNP and SINAPAD as natural partners for providing connectivity and computational resources, respectively. An additional international partner is Monash University (Melbourne, Australia) for access to Nimrod-G<sup>16</sup> based international testbeds and exploring applications based on Nimrod-O. As business partners, we have IBM participating through its academic software program and a local company (Taho) concentrating on wireless connectivity.

The objectives and goals of this joint project include: scalable computing infrastructure, tools and applications; tools and portals for monitoring, submission and scheduling of applications; development of some application-specific interfaces; development and integration of new services, integration of sensors and wireless resources; and application testbeds. The resulting activities distributed among the partners have been the following: implementation of a Grid with the inclusion of some of the partners' local clusters; implementation of a portal; establishment of policies; a monitoring service; scheduling policies and a scheduling service; a data integration service; aspects related to service orchestration; security conformance monitoring; network management services; automatic application transformation tools; accounting; and the porting of some applications.

The current grid infrastructure for the ComCiDis and InteGridade-Sinergia projects includes the use of Globus 2<sup>17</sup>, for interconnections, and of SGE<sup>18</sup>, OpenPBS<sup>19</sup>, and Condor<sup>20</sup> as schedulers within clusters. The implemented portal is servlet-based and includes a monitoring service

<sup>9</sup> ALICE (Latin America Interconnected with Europe - <http://www.dante.net/alice/>)

<sup>10</sup> WHREN/LILA - <http://whren.ampath.net/>

<sup>11</sup> InteGridade - <http://integridade.lncc.br/>

<sup>12</sup> National Center for Supercomputing Applications - University of Illinois Urbana-Champaign

<sup>13</sup> Brazilian Center for Physics Research - <http://www.cbpf.br/>

<sup>14</sup> Pontifical Catholic University of Rio de Janeiro - <http://www.inf.puc-rio.br/>

<sup>15</sup> Federal University of Espírito Santo - <http://www.inf.ufes.br/>

<sup>16</sup> The Nimrod Project - <http://www.csse.monash.edu.au/~david/nimrod/>

<sup>17</sup> Globus Project - <http://www.globus.org/>

<sup>18</sup> Sun Grid Engine Project - <http://gridengine.sunsource.net/>

<sup>19</sup> OpenPBS Portable Batch System - <http://www.openpbs.org>

<sup>20</sup> Condor Project - <http://www.cs.wisc.edu/condor/>

## Cyberinfrastructure for Multidisciplinary Science in Brazil

based on a LUA<sup>21</sup> script collecting information from Globus-MDS. Regarding some current activities we have been working on the development of a data integration service<sup>22</sup>, automatic application transformation developments based on EasyGrid<sup>23, 24</sup>, scheduling<sup>25</sup>, hierarchical submission<sup>26</sup>, dynamic adaptation<sup>27</sup>, and wireless grids<sup>28</sup>, among others. We are migrating to Globus 4 and in terms of security, we have been working with Globus certificates and are now moving to MyProxy<sup>29</sup>. OpenCA<sup>30</sup> is being used for certification in the SINAPAD grid.

Together with NCSA, activities include building cyberenvironments and global infrastructure. With LNCC activities include becoming an external international node of NCSA resources and a part of the NCSA Condor pool. This involvement also includes development of grid middleware services, portals for specific applications, scheduling algorithms and service, security issues, support for service-oriented applications, the definition of common services for a certain set of applications and fine-grain authorization.

Applications have been developed to use the cyberinfrastructure facilities (at LNCC and also at some of the partners) for use in bioinformatics, haemodynamics of the human cardiovascular system, oceanography, climate studies and geoprocessing, for which reference groups have been set up at LNCC. Other application areas include molecular dynamics (in physics), astronomy, engineering with developments for the oil industry, and environmental modelling of the Amazon region hydrologic basins, with some spin-offs such as e-knowledge and e-government.

In SINAPAD, the goals are to increase the number of regional centers from seven to ten, in order to cover the whole country, and to deploy a total computational and storage resources of 4 Tflops and 30 TB, respectively, in 2006, with respective increases to 5 Tflops and 50 TB in 2007, targeting applications demanding large data set storage and management. The better use of machines also depends on software, including new programming paradigms, user interfaces, and distributed databases - therefore, these are also areas for research and development and of investments.

In terms of networking, through the deployment of the IPÊ network in 2005 and the ongoing deployment of optical metro networks in capital cities expected to be completed by the end of 2006, RNP is bringing about a significant change in the quantity and quality of communications resources at the disposal of the Brazilian research and higher education community, permitting the widespread use of advanced applications. Future efforts will be directed towards extending these facilities more widely, bringing multiple gigabit connectivity to the remaining 17 state capitals and also to population centers outside the metropolitan districts of the national and state capitals.

<sup>21</sup> The Programming Language Lua – <http://www.lua.org/>

<sup>22</sup> Porto, F., Schulze, B. et al., An adaptive distributed query processing grid service, VLDB-DMG LNCS 3836, Springer Verlag 2005.

<sup>23</sup> EasyGrid Project – <http://easygrid.ic.uff.br/>

<sup>24</sup> Lima, B. A. et al., Efficient hierarchical self-scheduling for MPI applications executing in computational Grids, MGC 2004, ACM Press, p. 41-46, Oct. 2004

<sup>25</sup> Boeres, C. et al., Efficient hierarchical self-scheduling for MPI applications executing in computational Grids, MGC 2005, ACM Press, Nov. 2005, Nov. 2005.

<sup>26</sup> Vargas, P. et al., Hierarchical submission in a grid environment, MGC 2005, ACM Press, Nov. 2005. <sup>27</sup> EasyGrid Project – <http://easygrid.ic.uff.br/>

<sup>27</sup> Milanes, A., Rodriguez, N., Schulze, B., Managing jobs with an interpreted language for dynamic adaptation, MGC 2005, ACM Press, Nov. 2005.

<sup>28</sup> Lima, L. et al., Peer-to-Peer Resource Discovery in Mobile Grids, MGC 2005, ACM Press, Nov. 2005.

<sup>29</sup> MyProxy Credential Management Service – [myproxy.ncsa.uiuc.edu](http://myproxy.ncsa.uiuc.edu)

<sup>30</sup> OpenCA Labs – <http://www.openca.org/>

---

### Author Affiliation Links

National Laboratory for Scientific Computing, LNCC - <http://www.lncc.br/>

National Research and Education Network, RNP - <http://www.rnp.br/>

# GARUDA: India's National Grid Computing Initiative

## 1. Introduction

GARUDA<sup>1</sup> is a collaboration of science researchers and experimenters on a nationwide grid of computational nodes, mass storage and scientific instruments that aims to provide the technological advances required to enable data and compute intensive science for the 21st century. One of GARUDA's most important challenges is to strike the right balance between research and the daunting task of deploying innovation into some of the most complex scientific and engineering endeavors being undertaken today.

Building a commanding position in Grid computing is crucial for India. By allowing researchers to easily access supercomputer-level processing power and knowledge resources, grids will underpin progress in Indian science, engineering and business. The challenge facing India today is to turn technologies developed for researchers into industrial strength business tools.

The Department of Information Technology<sup>2</sup> (DIT), Government of India has funded the Centre for Development of Advanced Computing<sup>3</sup> (C-DAC) to deploy the nationwide computational grid 'GARUDA' which will connect 17 cities across the country in its Proof of Concept (PoC) phase with an aim to bring "Grid" networked computing to research labs and industry. GARUDA will accelerate India's drive to turn its substantial research investment into tangible economic benefits.

## 2. Objectives

GARUDA aims at strengthening and advancing scientific and technological excellence in the area of Grid and Peer-to-Peer technologies. The strategic objectives of GARUDA are to:

- Create a test bed for the research and engineering of technologies, architectures, standards and applications in Grid Computing
- Bring together all potential research, development and user groups who can help develop a national initiative on Grid computing
- Create the foundation for the next generation grids by addressing long term research issues in the strategic areas of knowledge and data management, programming models, architectures, grid management and monitoring, problem solving environments, grid tools and services

The following key deliverables have been identified as important to achieving the GARUDA objectives:

- Grid tools and services to provide an integrated infrastructure to applications and higher-level layers
- A Pan-Indian communication fabric to provide seamless and high-speed access to resources
- Aggregation of resources including compute clusters, storage and scientific instruments
- Creation of a consortium to collaborate on grid computing and contribute towards the aggregation of resources

N. Mohan Ram

Chief Investigator – GARUDA

S. Ramakrishnan

Director General – C-DAC

<sup>1</sup> <http://www.garudaindia.in/>

<sup>2</sup> <http://www.mit.gov.in/>

<sup>3</sup> <http://www.cdac.in/>

## GARUDA: India's National Grid Computing Initiative

- Grid enablement and deployment of select applications of national importance requiring aggregation of distributed resources

To achieve the above objectives, GARUDA brings together a critical mass of well-established researchers from 45 research laboratories and academic institutions that have formulated an ambitious program of activities.

### 3. Architecture

The major components of GARUDA (Figure 1) include the computing resources, high-speed communication fabric, middleware & security mechanisms, tools to support program development, collaborative environments, data management and grid monitoring & management. Access portals and specialized problem solving environments provide a seamless user interface to the Grid.

#### 3.1 Grid Resources

In the initial phase, the PARAM<sup>4</sup> Clusters at C-DAC labs in Bangalore, Pune, Hyderabad and Chennai will power the Grid. This provides a heterogeneous resource environment with clusters based on AIX, Solaris and Linux environments. The PARAM clusters are powered by PARAMNet<sup>5</sup> interconnect and C-DAC's HPCC<sup>6</sup> software. The PARAMNet system area network has 2.5 Gbps links and exports the Kshipra<sup>7</sup> lightweight communication protocol conforming to Virtual Interface Architecture (VIA) and MPI Application Programming Interface. The HPCC software provides a complete solution for creating and executing parallel programs on UNIX clusters through high performance communication protocols and a rich set of program development, system management and software engineering tools. This software is available on AIX, Solaris and Linux cluster environments. As the project progresses, GARUDA partners are expected to contribute resources including specialized scientific instruments.

#### 3.2 The Communication Fabric

The GARUDA network is a Layer 2/3 MPLS Virtual Private Network (VPN) connecting select institutions at 10/100 Mbps with stringent quality and service level agreements. The multi-services network with a total backbone throughput of 2.43 Gbps, connects 17 cities (Figure 2) covering 45 research and academic institutions across the country. It is expected to support not only the traffic requirements of high performance computing applications but also other requirements like that of IP-based collaborative environments enabled through video conferencing and Access Grid.



Figure 1. GARUDA Components

<sup>4</sup> <http://www.cdac.in/html/hpcc.asp>

<sup>5</sup> <http://www.cdac.in/html/htdg/products.asp>

<sup>6</sup> <http://www.cdac.in/html/ssdgbllr/products.asp>

<sup>7</sup> <http://www.cdac.in/html/ssdgbllr/kshipra.asp>



Figure 2. GARUDA Connectivity



### 3.3 Grid Monitoring and Management

A dedicated Grid monitoring and management centre at C-DAC, Bangalore helps in managing and monitoring all the components in the Grid. State-of-the-art display walls and advanced software like *Paryaveekshanam* (Figure 3), developed at C-DAC, help in effectively monitoring the health and utilization of various components of the Grid. A mobile agent framework for monitoring the Grid resources and also for automatic update of software releases is being explored.

Proposed research activities include exploring advanced network services, development of novel architectures, integration of network services into the Grid middleware, deployment of IPv6 and alternate protocols to overcome the shortcomings of IP over high-speed networks. This fabric is a pre-cursor to the next generation Gigabit network and is being deployed in collaboration with ERNET<sup>8</sup> – a scientific society under the Department of Information Technology. A simulation model of the network is being developed to understand the impact of change in traffic profiles on the performance and in providing inputs to decide on the architecture of the fabric for the next phase of the project.

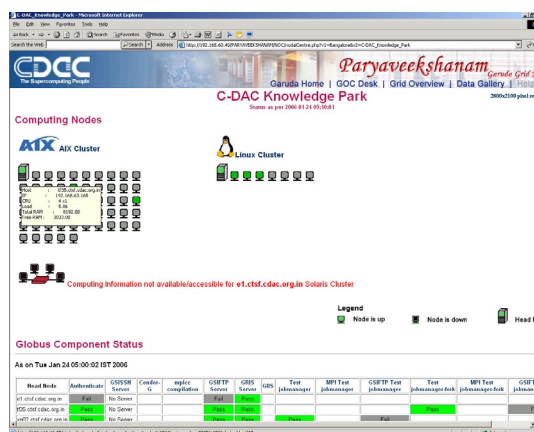

Figure 3. GARUDA Monitoring Tool

<sup>8</sup> <http://www.eis.ernet.in/>

### 3.4 Grid Middleware

Recent trends in Grid Computing indicate that the standardization of the Grid programming model and associated management services is still under progress. The Open Grid Services Architecture<sup>9</sup> (OGSA) represents an evolution towards a Grid system architecture based on Web services. OGSA compliant, higher-level functions are beginning to be implemented. Therefore, GARUDA has adopted a pragmatic approach for using existing Grid infrastructure and Web Services technologies. The deployment of grid tools and services for GARUDA will be based on a judicious mix of in-house developed components, the Globus Toolkit (GT) and industry grade components. GT2<sup>10</sup> will be deployed on the GARUDA grid for operational requirements while researchers will experiment with GT4<sup>11</sup> at the Grid labs.

<sup>9</sup> <http://www.globus.org/ogsa/>

<sup>10,11</sup> <http://www.globus.org/toolkit/>

The resource management and scheduling in GARUDA is based on a deployment of industry grade schedulers in a hierarchical architecture. At the cluster level, scheduling is achieved through Load Leveler<sup>12</sup> for AIX platforms and Torque<sup>13</sup> for Solaris and Linux clusters. At the Grid level, the Moab<sup>14</sup> scheduler from Cluster Resources<sup>15</sup> interfaces with the various cluster level schedulers to transparently map user requests onto available resources in the Grid. Moab supports advanced features including intelligent data staging, co-allocation and multi-sourcing, service monitoring and management, sovereignty (local vs. central management policies), virtual private cluster and virtual private grid. Moab interfaces with Globus for data and user management, job staging and security.

<sup>12</sup> <http://www.redbooks.ibm.com/redbooks/SG246038.html>

<sup>13</sup> <http://www.clusterresources.com/pages/products/torque-resource-manager.php>

<sup>14</sup> <http://www.clusterresources.com/pages/products/maob-cluster-suite.php>

<sup>15</sup> <http://www.clusterresources.com/>

### 3.5 Data Management

To enable data oriented applications, GARUDA provides an integrated but distributed data storage architecture by deploying the Storage Resource Broker<sup>16</sup> (SRB) from Nirvana.<sup>17</sup> SRB creates and maintains a Global Namespace across multiple heterogeneous and distributed

<sup>16</sup> <http://www.nirvanastorage.com/products/products-main.htm>

<sup>17</sup> <http://www.nirvanastorage.com/>

## **GARUDA: India's National Grid Computing Initiative**

storage systems in the Grid. The Global Namespace is a hierarchical organization of all collections, sub-collections, and data objects in the SRB Federation, independent of their physical storage infrastructure. Access is virtualized through a single sign-on and interface through one common set of APIs. The SRB provides advanced services including transparent data load and retrieval, data replication, persistent migration, data backup and restore, and secure queries. Data security is ensured through the following mechanisms: authentication, authorization, tickets, encryption, access control lists, audit trails and role based classification of users. SRB achieves performance through parallel I/O, bulk operations, latency minimization, scalable implementation and a transaction based architecture. Data management is also automated through launch of daemons automatically on start-up.

### **3.6 Program Development**

Program Development Environment (PDE) enables users to carry out an entire program development life cycle for the Grid. During the program development cycle the user prototypes, implements, debugs and tunes his application. PDEs help users to express, manipulate and manage complex workflows, and also facilitate development using Grid specific programming languages such as scripting languages and workflow languages. They also help to reduce the complexities of understanding different environments as they act as a standard environment across all the resources of the Grid.

The GARUDA PDE includes basic program development tools such as editors and compilers; program analysis tools like debuggers and profilers; workflow environments and tools that help in porting, conversion and scalability. For a seamless interface to the user it would be ideal if all these components are made available through an Integrated Development Environment (Grid IDE). In the initial phase of the project the work will be focused towards delivering a debugger for the grid environment. This debugger will have features similar to DIViA,<sup>18</sup> which is an integrated debugging environment available on the PARAM clusters.

<sup>18</sup> <http://www.cdac.in/html/ssdgbldr/divia.asp>

### **3.7 Access Methods**

The GARUDA portal, which provides the user interface to the Grid resources, hides the complexity of the Grid from the users. It allows submission of both sequential and parallel jobs and also provides job accounting facilities. Problem Solving Environments (PSE) in the domains of Bio-informatics, Cryptanalysis and Community Atmospheric Model support the entire cycle of problem solving for the specific domains by supporting problem formulation, algorithm selection, numerical simulation and solution visualization.

Access to the Grid resources can either be through the high-speed communication fabric or over the Internet. Access through satellite based communication channels is also being explored as part of a research initiative to integrate the GARUDA terrestrial grid with a satellite based grid. Research on Semantic Grids is underway in collaboration with MIT,<sup>19</sup> Chennai. The initial focus will be on publishing and intelligent discovery of Grid services. These capabilities will be integrated with the GARUDA portal to make access to the Grid seamless to the users.

<sup>19</sup> <http://www.mitindia.edu/>

### **3.8 Applications**

Applications of national importance that require aggregation of geographically distributed resources will be developed and deployed on the GARUDA Grid. Natural Disaster Management and bio-informatics applications that are characterized by intensive computing and data access requirements are being targeted during this phase.

C-DAC in association with a partner research institution will mine data from a network of sensors deployed over vast disaster prone regions and upload it to GARUDA as input to forecast models appropriate to various stages of disaster management. This will enable timely dissemination of disaster information to user agencies for effective mitigation and relief measures.

C-DAC's Bio-informatics Resource and Applications Facility<sup>20</sup> (BRAAF) on the PARAM Supercomputing facility is accessible for the bio-informatics research community involved in insilico molecule identification and new drug discovery. The enormity of data and complexity of algorithms require tremendous computational cycles and storage. This demands effective use of grid resources beyond those available at any single location.

<sup>20</sup> <http://bioinfo-portal.cdac.in/>

#### **4. Project Dissemination**

A public website [www.garudaindia.in](http://www.garudaindia.in) provides the required mechanism for the GARUDA Grid community to exchange and disseminate information periodically. GARUDA publications, technical reports and newsletters can be accessed through this site. C-DAC will organize a set of thematic workshops and conferences on a regular basis. Training activities will be organized to ensure that the users of GARUDA are kept abreast of the latest technological advancements in Grid Computing.

#### **5. Conclusion**

GARUDA will demonstrate the power of the Grid by deploying select applications of national importance over the test bed. It will eliminate the barriers to the coordinated use of national resources, regardless of the physical location of these resources and their users. For the first time in the country, it will provide a persistent and supported set of Grid infrastructure and deployable services. This infrastructure will provide a range of new Grid services addressing issues of resource discovery, secure access, resource monitoring and management, distributed data management and the like. Our goal in creating this national infrastructure is to enable novel approaches to scientific computing based on emerging concepts, the outcome of which will lead to revolutionary changes in a wide range of scientific disciplines across the country.

---

# Cyber Science Infrastructure Initiative for Boosting Japan's Scientific Research

## 1. Introduction

The Cyber Science Infrastructure (CSI) is a new comprehensive framework in which Japanese universities and research institutions are collaboratively constructing an information technology (IT) based environment to boost scientific research and education activities. Various initiatives are reorganized and included in CSI, such as the national research grid initiative, the university PKI and authentication system initiative, and the academic digital contents projects, as well as the project for a next-generation high-speed network. CSI was launched in late 2004 as a collaborative effort of leading universities, research institutions, and the National Institute of Informatics (NII).

NII is an interuniversity research institution that was established in April 2000 to conduct comprehensive research on informatics; it is the only academic research institution dedicated to informatics and IT. The Institute also been assigned a pivotal role in developing a scientific information and networking infrastructure for Japan. Therefore, NII also has a service operation arm for networking and providing scholarly information. NII puts priority on developing cutting-edge technologies for networks and information services and maintaining an infrastructure that will improve the networking and information environment of Japanese universities and research institutions.

In this article, we describe the current CSI activities being coordinated by NII as a collaborative effort with Japanese universities and research institutions.

## 2. Cyber Science Infrastructure as Next-generation Academic Information Environment

For more than 20 years, NII and its predecessor institution, NACSIS, have provided a network and information service infrastructure for Japanese universities and research institutions, with the budgetary support of Japan's Ministry of Education, Culture, Sports, Science and Technology (MEXT). In this undertaking, NII is responsible for planning a better information environment and being a coordinator that can meet the diverse expectations of research communities and higher education institutions.

After the corporatization of Japanese national universities in April 2004, which significantly impacted research and educational communities and brought about the transformation of university administration systems, NII began a new network coordination initiative with leading universities and research communities that were shifting towards IT-based research. NII believes that some sort of core body is necessary to lead an initiative that deals with issues shared by many research and educational institutions. In addition to the network coordination, it considers the following three goals to be urgent for the Japanese research community:

- Design and deployment of a next-generation high-speed network for research institutions and operation of this network as a stable information infrastructure for research and education activities,
- Development of scholarly databases and digital libraries, enabling the dissemination of scholarly information from research institutions, and
- Promotion of informatics research jointly undertaken with universities.

Masao Sakauchi  
Shigeki Yamada  
Noboru Sonehara  
Shigeo Urushidani  
Jun Adachi

Kazunobu Konishi  
National Institute of Informatics (NII), Tokyo,  
Japan

Satoshi Matuoka  
Tokyo Institute of Technology / NII

---



Accomplishing these goals is NII's most important mission, so NII has integrated its activities for developing information infrastructures into the Cyber Science Infrastructure (CSI) initiative, incorporating the prospect of cooperating with researchers outside NII who share these three goals. The executive organization for network planning and coordination was created by NII in early 2005. It identifies CSI as a joint initiative among universities and research institutions aimed at evolving the nation's scientific information infrastructure.

In 2005, the CSI initiative obtained support from MEXT and the Council for Science and Technology Policy of the Japanese government and emphasized CSI's importance as a national initiative by ensuring that NII's budget in the fiscal year 2006 would include funds for CSI. The executive framework for development and dissemination of scholarly information is also part of this initiative, as is the framework for network-related activities, which include the next-generation high-speed optical network, the national research grid initiative, and PKI implementation.

### 3. Japanese Academic Networking

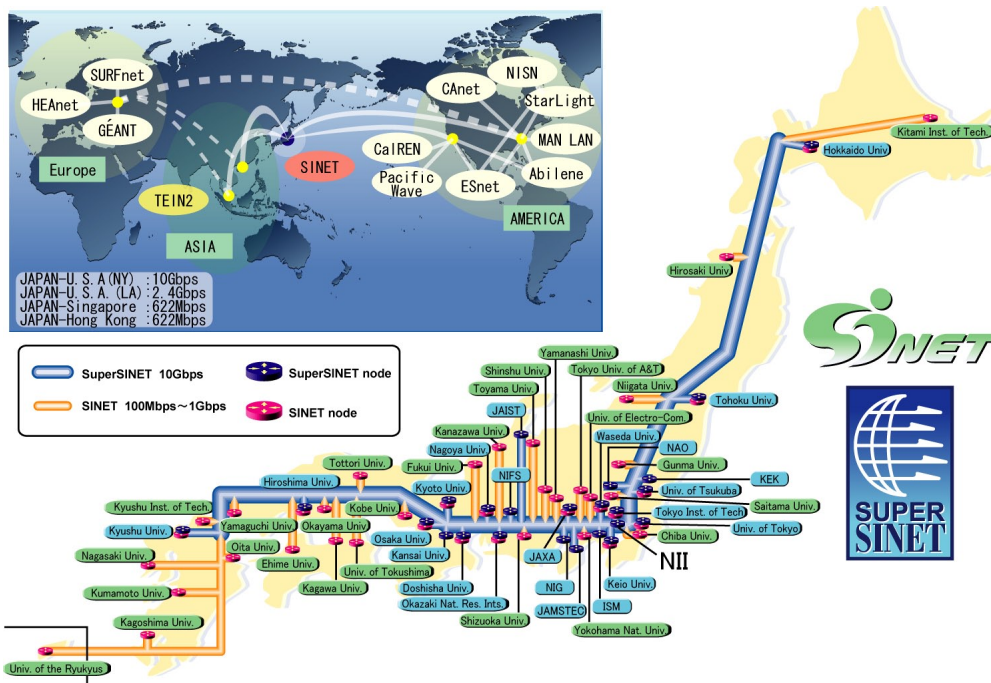

Figure 1. Configuration of SINET, Super SINET and SINET/Asia (As of 2005)

#### 3.1 History and the Current Network

NII started its network operations in 1987 as a major service for universities and research institutions throughout Japan. At first, it employed a X.25 packet switching network for connecting computer centers in universities. In 1992, when an important issue was the improvement of campus information environments, it adopted Internet Protocols for interconnecting campus networks. Since then, this academic Internet backbone, called the Science Information Network (SINET)<sup>1</sup>, has been expanded in an effort to promote research and education and to disseminate scholarly information for universities and research institutions. As shown in Fig. 1, 44 network nodes are currently deployed at major universities and research institutions. The lines from other institutions are collected at routers on the nodes. In 2005, 722 institutions were using SINET as an indispensable infrastructure for their daily activities. All of the nodes are connected with 1-Gbps or faster optical networks and the backbone speed is 10-Gbps.

<sup>1</sup> <http://www.sinet.ad.jp/>

## Cyber Science Infrastructure Initiative for Boosting Japan's Scientific Research

SINET operates overseas connections as well. The 10-Gbps line to Abilene in the U.S. is the most heavily used Internet connection to Western countries, and GEANT in Europe is connected through this circuit. SINET also has a 2.4-Gbps line to Los Angeles in the U.S.

In January 2006, SINET launched SINET/Asia operations by deploying 622-Mbps international lines to Singapore and Hong Kong. These lines are used as Internet connections among Asian countries and Australia. The cooperation of the TEIN2 project initiated by the European Union has also meant that SINET will eventually have another path to Europe through this south-bound internetworking.

### 3.2 Super SINET

In 2002, NII launched the Super SINET initiative to provide a cutting-edge network infrastructure for research projects involving large amounts of data and supercomputers. Super SINET provides a 10-Gbps network environment and high-speed routers at selected nodes to meet the enormous bandwidth requirements of high-speed network-dependent research on high-energy physics, nuclear fusion science, space and astronomical science, genome analysis, and nanotechnology research. It is interconnected with SINET, and both networks are being operated in a multi-tier manner. Super SINET is also employed for the grid initiative called NAREGI (National Research Grid Initiative).

### 3.3 Next-Generation Networks in CSI

Although SINET and Super SINET have served admirably as the Japanese science infrastructure, their traffic volume has been rapidly growing, and their user requirements have become more diversified. A future science infrastructure that supports research on a variety of leading-edge applications will have to provide adequate network services to its users and respond flexibly to changes in their requirements. NII is therefore planning to construct a next-generation network that integrates both SINET and Super SINET.

Figure 2 shows the high-level description of the network architecture for this next-generation SINET. The transport network is a hybrid IP and optical network that accommodates multiple-layer services such as IP, Ethernet, and layer-1 (dedicated line) services. The network resource, i.e., network bandwidth, is flexibly assigned to each layer corresponding to the demand. For example, the bandwidth for a layer-1 connection can be assigned on demand by reducing the bandwidth for layers 2 and 3. Next-generation SDH/SONET technologies such as the General Frame Protocol (GFP), Virtual Concatenation (VCAT), and Link Capacity Adjustment Scheme (LCAS) will be essential to realizing this flexible network architecture. Generalized Multi-Protocol Label Switching (GMPLS) is also a key technology to achieve bandwidth on demand (BoD) services. IP routers provide a converged IP/MPLS platform for layer 2 and 3 services. L2 and L3 Virtual Private Network (VPN) over MPLS, IPv4/IPv6 dual stack, and sophisticated QoS will be common infrastructural functions.

To optimize network resource utilization and to enhance network resilience, the network has to supervise multiple layers and find the optimal resource assignment dynamically. The growth in the traffic of layer 1 services means that we will need a network control platform that can efficiently and dynamically monitor and control multiple layers.

A service control platform that helps to accelerate development of user applications by enabling collaboration between users and the network will be very important in the future infrastructure. The platform will include on-demand bandwidth assignment, advanced network

security, and collaboration between middleware/applications and the network. We plan to start deployment of the next-generation SINET in 2007. We believe that this improved network will provide better environments for Japanese universities and research communities.

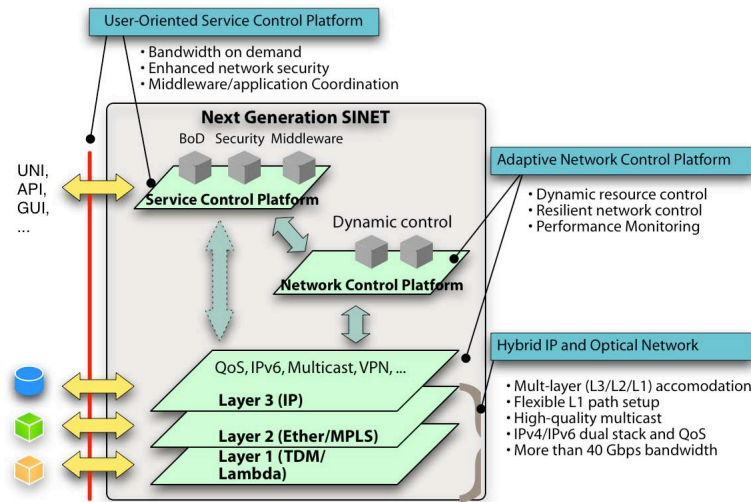

Figure 2. Network architecture for the Next-generation SINET

### 3.4 University PKI Initiative in CSI

To facilitate interoperability and availability of the next-generation network and the grid middleware among universities, we also have to ensure a secure and reliable operation environment for universities which have diversified research and education policies. It is for this purpose that we launched the University Public Key Infrastructure (UPKI) initiative in 2005. The initiative will bring together informatics researchers at major universities and research institutions, and it is initially intended to be a means to exchange course credits among universities and to authenticate cooperative research activities. The developers are designing a universal scheme for the campus-wide authentication and authorization system and its applications for the Japanese university environment. The UPKI initiative is expected to be the key to promote sharing of computing facilities and information resources among institutions participating in CSI.

## 4. National Research Grid Initiative in CSI

The National Research Grid Initiative (NAREGI)<sup>2</sup>, is one of the core projects within CSI. It started as the five-year Japanese National Grid Project 2003–2007, with over \$100 million dedicated budgetary allocation. It is hosted by NII and led by Ken-ichi Miura. The chief aim of NAREGI is to develop a set of grid middleware to serve as a basis for CSI and other international grid infrastructural efforts. It will also serve as the centerpiece for constructing a nationwide research grid infrastructure. (Recent decisions have been made to extend NAREGI beyond 2007 via consolidation with the recent petascale computing national project.)

<sup>2</sup> <http://www.naregi.org/>

To achieve these goals, over 100 professional software developers from computing vendors such as Fujitsu, NEC, and Hitachi are working together in groups called working packages (WP) on a comprehensive middleware stack (Figure 3) under the leadership of NII professors who technically supervise the respective WPs; this is a unique combination of academic and

## Cyber Science Infrastructure Initiative for Boosting Japan's Scientific Research

industrial talents not seen in other major international grid projects. NAREGI is also strongly investing in the standardization of grid middleware, especially the OGSA (Open Grid Services Architecture) in GGF (the Global Grid Forum)<sup>3</sup>, and has actively adopted the standards of other organizations whenever possible. NAREGI will also collaborate with other international grid infrastructure projects, such as the TeraGrid and OSG in the U.S., EGEE and DEISA in Europe, as well as national-level projects in the Asia-Pacific region. Starting in 2005, NAREGI has held several interoperability meetings between TeraGrid and EGEE, and plans to set milestones so that the middleware stacks of the different projects will be interoperable at various levels in order to host virtual organizations on international scales.

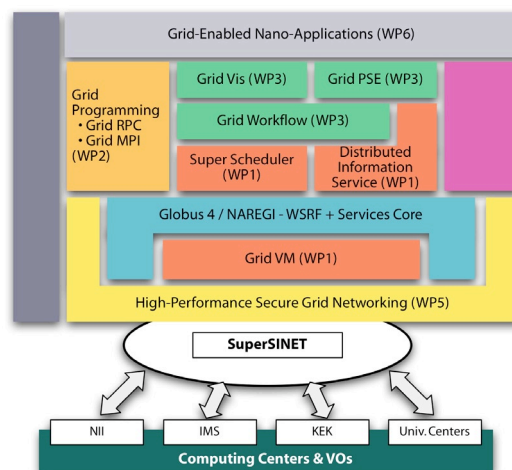

<sup>3</sup> <http://www.ggf.org/>

Figure 3. Overview of the NAREGI Software Stack for the Beta Version, Spring 2006

Another essential aspect of NAREGI is the inclusion of nanoscience as an “early adopter” application area and a virtual organization (VO). The Institute for Molecular Science (IMS) located in Okazaki, Japan, is serving as the VO hosting institution. The experimental deployment of grid-enabled nanoscience applications over the NAREGI testbed, together with a production environment that will be hosted by the computing centers, will be significant in terms of the scale of the computational requirements, and it will affect academia and industry users who work in nanoscience and nanotechnology.

NII, which hosts the overall project as well as the Center for Grid Middleware Research and Development, and IMS collectively operate the dedicated NAREGI testbed. The testbed uses the Super SINET optical network as the underlying network infrastructure. It currently facilitates nearly 18 Tflops of computing power distributed over nearly 3000 processors (Figure 4) and is in heavy use for middleware development and grid-enabled nanoscience applications. The presence of a dedicated non-commercial testbed has proven absolutely essential in enabling large teams to collaborate toward reaching R&D goals and fostering integration.

The project's initial milestone of internal alpha delivery of middleware was met in the spring of 2005, and the near-production quality and standards-setting/compliant beta version will be ready for the Global Grid Forum 17 in Tokyo in May 2006. Several virtual organizations will also begin operation in 2006, including ones for nanoscience, high-energy physics, and the consortium of major university centers. There will be releases over the next two years to refine and enhance the middleware capabilities so that NAREGI can be used in a 24/7 fashion at major computing centers around the world.

As of early 2006, the project target of achieving a 100 Tflop-scale, CSI production grid seems easily achievable in terms of the computing capacity of the facilities involved in the project.



Thus, to support grids that are beyond the petascale, the NAREGI project will be “upscaled” starting April 2006. That is, NAREGI will become part of the new petascale high-performance computing initiative, aiming to construct a computing environment that will be centered around a next-generation Earth Simulator-class machine that will exceed 10 Pflops by 2011, and will be supplemented by a fleet of centers, each of which will host a petascale machine, constituting a nationwide multi-petascale grid. The NAREGI project will thus last until the spring of 2011 or even beyond, with developments to focus on hosting a grid of enormous computing capacity. NAREGI will collaborate with other CSI efforts, such as the national-scale UPKI, so that every researcher and student can have access to the national grid.

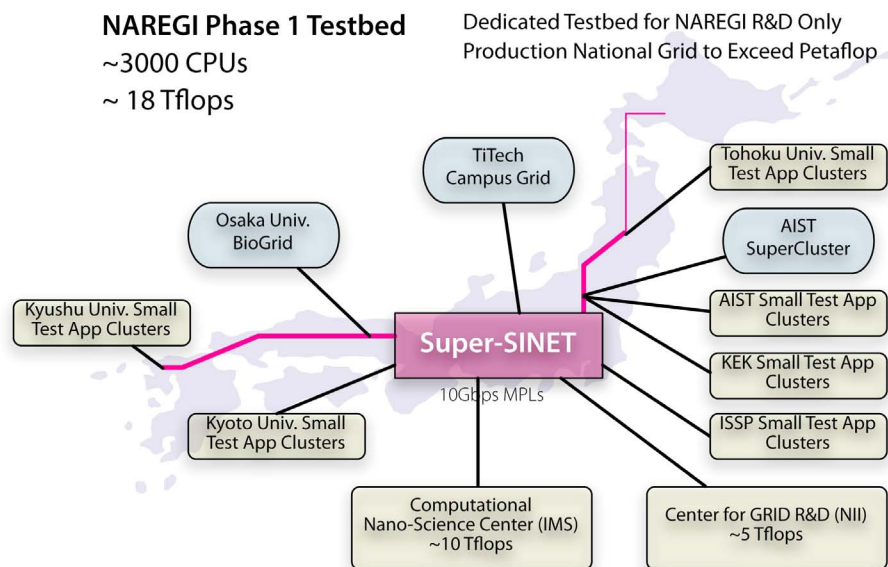

Figure 4. NAREGI R&D Testbed

## 5. Provision of Academic Digital Contents in CSI

### 5.1 NII's Scholarly Information Services

NII provides a wide range of academic digital contents services that contribute to the research activities of CSI. In April 2005, NII launched GeNii<sup>4</sup> as a unified portal of databases on various academic subjects. GeNii currently offers four services: CiNii, Webcat Plus, KAKEN, and NII-DBR. GeNii provides a meta-search interface that allows simultaneous searches across the four databases as well as individual search interfaces that fully utilize the features of each database. CiNii offers comprehensive information on research articles written in Japanese. NII provides nearly 2.4 million full-text articles from Japanese academic journals and research bulletins published by universities. Webcat Plus provides bibliographic information on books and serials by means of the Union Catalog Database of NACSIS-CAT, which was established by NII and Japanese university libraries in 1985. NII has added many bibliographic records to Webcat Plus, which now includes nearly 12 million records. One of Webcat Plus's features is its “associative search” function. This function makes it possible to conduct intuitive searches in a way that is similar to human thinking processes. The KAKEN database offers information on the research activities supported by Grants-in-Aid for Scientific Research from MEXT, and NII-DBR is a collection of multi-disciplinary databases on Japanese academic societies and researchers.

<sup>4</sup> <http://ge.nii.ac.jp/>



---

## Cyber Science Infrastructure Initiative for Boosting Japan's Scientific Research

### 5.2 Joint Repository of Electronic Journals

The university libraries' consortia and NII jointly operate an electronic journal repository, called NII-REO. The repository provides long-term access to electronic journals that are indispensable for academic research. About 60,000 articles from several scholarly publishers are currently stored on the REO server. Furthermore, the large-scale archival digital contents of Springer-Verlag and Oxford University Press journals, which go back to the 19th century, will be added to this collection in 2006. These materials are being utilized by the participating universities. NII and the university libraries are planning to add more titles to this digital archive upon the completion of negotiations with other publishers.

### 5.3 Institutional Repositories Initiative

Institutional repositories are digital collections that manage and disseminate scholarly materials created by an institution and its members. They address two strategic issues facing academic institutions: they provide a central component for reforming scholarly communications and they serve as tangible indicators of an institution's quality and activities, thus increasing its visibility, prestige, and public value.

In recent years, more and more academic libraries have started to construct institutional repositories. In 2005, NII started a collaborative project with 19 university libraries aiming at deployment and coordination of institutional repositories in Japan. By using the Open Archives Initiative Protocol for Metadata Harvesting (OAI-PMH), NII will harvest metadata from institutional repositories and develop a centralized metadata repository, for which it intends to offer various value-added services to the scholarly community. Other roles that NII will assume in this initiative include conducting activities to aid the formation of an institutional repository community and providing technical support and advocacy services.

## 6. Concluding Remarks

The Cyber Science Infrastructure (CSI) is the new initiative for evolving Japan's academic information infrastructure. It was launched in 2005 by NII and is supported by Japanese universities and research institutions. Its executive organization is working to elaborate the comprehensive concept behind CSI; some issues have already been addressed. For example, the detailed specification of the next-generation network will soon be settled on and will reflect the technical advice of many researchers. Procurements will begin in April 2006 and deployment will start in April 2007. Furthermore, the budget for developing the UPKI software has been partially appropriated for the fiscal year 2006. The progress of the CSI initiative will be reported in various research papers as well as on our web site.

---

**Acknowledgements:** Many people have contributed to the development of the core concept of CSI. In particular, the authors would like to express their sincere appreciation to Ken'ichi Miura and Shinji Shimojo, who are eagerly working for CSI and NAREGI, and our colleagues who contribute to various CSI projects at supercomputer centers of major universities.

# Construction and Utilization of the Cyberinfrastructure in Korea

## 1. Introduction

The number of subscribers for high-speed internet service in Korea reached more than twelve million at the end of 2005. This was the result of a national project, VSIN (Very high Speed Information Network), which was launched in 1995 by MIC (Ministry of Information and Communication) of Korea. The most notable result was the completion of a nation-wide optical communication cable infrastructure. It has provided high-speed communication networks to most commercial buildings and apartments in Korea. The Korean government then built internet services upon the infrastructure, which enabled e-government services, e-commerce services, and other IT application services with low cost and high quality.

The governmental budget for science and technology research and development reached 7 trillion won (about \$7 billion US) in 2005. After the success of VSIN, the Korean government has tried to enhance the competitiveness of science and technology, such as bio-technology and nano-technology, by introducing VSIN and advanced IT technologies, such as the Grid, to the research processes of science and technology, which lags relatively behind developed countries. As a part of the plan, an initiative for the comprehensive implementation of Korean national Grid infrastructure (K\*Grid) was started in 2002 by MIC.

KISTI (Korea Institute of Science and Technology Information) plays a leading role in construction and operation of the production quality Grid infrastructure needed for large-scale collaborative research in scientific and commercial applications. The main goal of the K\*Grid infrastructure, which integrates huge amounts of computing power, massive storage systems, and experimental facilities as a virtual single system, is to provide an extremely powerful research environment for both industries and academia. The K\*Grid project includes construction of the K\*Grid infrastructure including Access Grid, development of its middleware, and research and development of Grid applications.

In this article, the current status and activities about the construction and utilization of the cyberinfrastructure in Korea is described.

## 2. Construction of the K\*Grid infrastructure

The construction of the K\*Grid infrastructure is divided into two phases: the first phase (2002-2004) was for constructing Grid testbeds and providing basic Grid services with 15 small-scale cluster systems from computing centers and university laboratories. As the interests in Grid have increased, the demand for a sustainable, production level Grid infrastructure has been rapidly growing not only from users from the K\*Grid project, but also from related projects such as, e-Science project of Korea and KoCED (Korea Construction Engineering Development) project.

The second phase (2005-2006) of the K\*Grid infrastructure is the result of such requirements. Its objective is to construct a reliable Grid service infrastructure for TFLOPS level. At present, three organizations, SNU (Seoul National University), PNU (Pusan National University) and KISTI, are involved. They are making invaluable contributions for sharing high-performance

Hyeongwoo Park

Pillwoo Lee

Jongsuk Ruth Lee

Sungho Kim

Jaiseung Kwak

Kum Won Cho

Sang-Beom Lim

Jysoo Lee

KISTI (Korea Institute of Science and Technology Information) Supercomputing Center, Korea

## Construction and Utilization of the Cyberinfrastructure in Korea

computing resources using the scientific research network of KREONET (Korea Research Environment Open NETwork).

The K\*Grid portal, a web-based Grid service platform for providing an easy-to-use environment to the user, has been developed based on Java and web service technology. It provides a job management and execution environment, and various application modules will be integrated later based on requirements from application researchers. The K\*Grid infrastructure is expected to be used in diverse fields, far beyond traditional applications of supercomputing. It is expected to play a pivotal role in R&D in Korea as the research and development cyberinfrastructure of Korea.

AG activity in Korea started in 2002 as a part of the K\*Grid project. The AG infrastructure of Korea started as a one room type node at KISTI and developed into a six room type with over fifty PIG (Personal Interface to the Access Grid) nodes that are actively used in such areas as e-Science, bioinformatics, medicine, meteorology. The long term goal of AG activities in Korea is to provide enhanced AG systems as the next generation high-end collaborative infrastructure for researchers in Korea.

In order to facilitate a domestic AG community, KISTI develops various additional AG servers, provides enhanced services and technical support, and holds annual workshop and tutorials. KISTI also has been conducting research to enhance the performance of the AG infrastructure, such as a high quality media stream transmission and a high adaptive network compatibility tool for AG connector, which provides easy access from several types of networks such as NAT, VPN, and through firewalls. MEET (Multicast Debugging Toolkit with End-to-End Packet Trace), a near real-time multicast accessibility and quality monitoring framework with a web-based graphical user interface, is also being developed. MEET is able to (1) carry out proactive multicast diagnosis, and (2) provide easy accessibility for multicast users via the toolkit. In addition, an HDTV media stream transmission over AG technique has been developed and deployed, and international joint research with ANL toward building the next AGTk (Access Grid Toolkit) with an AGPM (Access Grid Package Manager) technique is in progress.

AG is being used in increasingly diverse situations, such as remote medical examination and treatment, bioinformatics, and education. In particular, usage in the medical area is very significant -- it is currently used in remote lecture, remote presentation, remote workshop, and it is expected that usage in remote surgery as well as remote collaborative medical examination and treatment will be popular in the near future. KISTI's AG has also been used to help international collaboration in such areas as Grid, supercomputing application research, medicine and bioinformatics.

### 3. Development of K\*Grid Middleware

K\*Grid middleware has been developed as a part of the K\*Grid project. KMI-R1 (K\*Grid Middleware Initiative - Release 1) is an integrated Grid middleware package that helps scientists to easily setup computational and data Grid environments for their research as well as harness all the advantages of Grid at their fingertips. KMI was originally developed for the K\*Grid infrastructure (see Figure 1) but is not limited to it. KMI-R1 is an integration of the MoreDream Toolkit (developed by KISTI) with some key software packages such as Globus Toolkit (developed by ANL), KGridCA system (developed by KISTI) for the Grid certificate authority service, AIService (developed by KISTI) for the Grid accounting service, SRB (Storage

Resource Broker, developed by SDSC), and KMI-GridSphere (optimized with GridSphere developed by GridLab).

MoreDream is a Grid middleware toolkit which allows scientists in many application areas to easily use the Grid environment and to utilize necessary resources, such as computing resources, data, storage, and experts geographically and organizationally distributed. In the MoreDream project, three research issues beneficial to scientists are the foci. The major components of MoreDream (Figure 2) are GRASP (Grid Resource Allocation Services Package) for Grid resource allocation service, GAIS (Grid Advanced Information System) for Grid information service, and MPICH-GX for parallel computing service. Each component has extended functionalities of the Globus Toolkit 3 (GT3). The services of MoreDream are implemented based on the OGSi (Open Grid Service Infrastructure) of GT3.

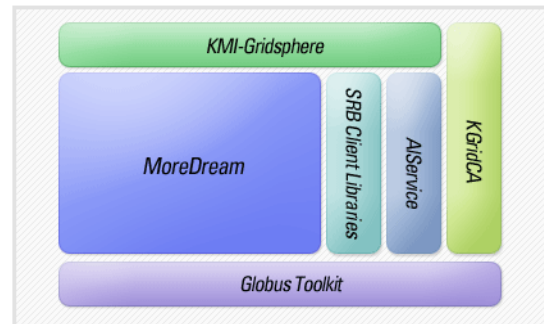

Figure 1. Components of KMI-R1

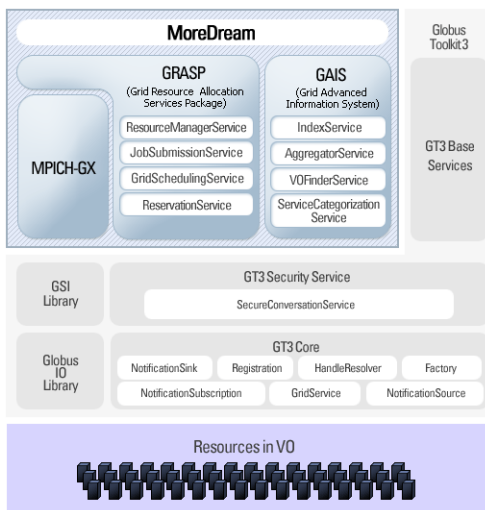

Figure 2. Architecture of MoreDream Toolkit

in the K\*Grid. MPICH-GX is an enhancement of MPICH-G2, extending functionalities required in the Grid. MPICH-G2 is a well-defined implementation of Grid-enabled MPI, but it need to be modified for supporting some requirements of Grid applications. The detailed information about all the components of KMI-R1 can be found at <http://kmi.moredream.org/>.

#### 4. Researches on Grid Application of K\*Grid

Research on Grid application has been conducted as a part of the K\*Grid Project. Its primary goal is to develop Grid-based applications to improve the quality of service via Grid technology and to gather requirements from various applications for further research. Scientific application had been the major focus until 2004, and now its focus has shifted to IT applications such as on-line game service, telematics navigation service and rendering service.

## Construction and Utilization of the Cyberinfrastructure in Korea

### Grid-based Telematics Navigation Service

Firstly we developed a high quality telematics navigation service based on Grid Technology. It serves realistic 3D image content in the Grid environment. The Grid-based telematics navigation service is composed of four elements: Grid-based load-balancer, navigation client, 3D image provider and load monitoring agent.

### Grid based Online Game Service

The objective is to develop a high quality online game service on the Grid environment and allocate a real-time game server according to the number of concurrent game users. We developed an online game server from a Grid pool constructed by MoreDream middleware that manages game daemons. It is composed of four elements: lobby host, room host, data center and monitoring tool (Figure 3).

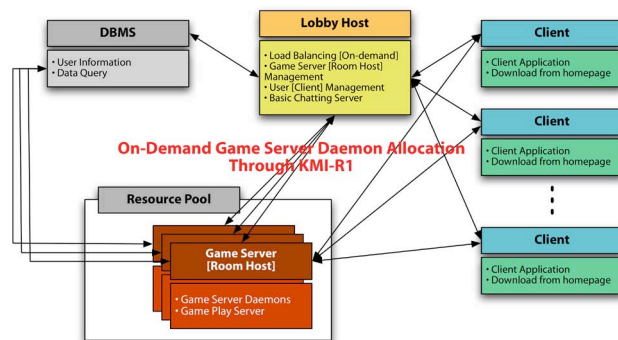

Figure 3. Grid based online game server architecture and functions

### Grid based Rendering Service

The objective of Grid based rendering service is to accomplish a commercial or non-commercial rendering project on the Grid environment. Locally distributed render farms (Daejeon, Seoul) are interoperated by RenMan™, which manages and accomplishes rendering services based on the Grid. Table 1 below shows what has been accomplished in the system.

Manufacturer	Renderer	Production	Contents	Execution Time (hour)	Remark
DOES	3D-MAX 7.0	Anycall CF in "AnyParty" of Anycall CF in Samsung	TV, theater in HD format	8	Simple distributed processing
HUG	MAYA 6.5	PR image for National Health Insurance Corporation	Large number of jobs	25	Ray Tracing
AURUM	MAYA 7.0	Model House Simulation for Daewoo Apartment	Extremely realistic expression	8	Simple distributed processing
SEMOLogic	MAYA 7.0	"God of War II" intro movie for PlayStation II in Sony Computer Entertainment(US)	3.2GB Input data	1 frame is divided to 12 layers	6/ Frame

Table 1. System Accomplishments



## 5. Korea e-Science Project

The main focus of the K\*Grid project is for the construction of next generation internet and business applications, and little attention is given to scientific applications. In order to complement the situation, the Korea e-Science project started by MOST (Ministry of Science and Technology) of Korea with the intention of providing advanced collaborative environments to researchers distributed over the country.

### e-Science Applications

Currently, advanced environments, or problem solving environments, are being constructed in five application areas (Table 2) as a part of the Korea e-Science Project. Each application will be developed using common application support software and infrastructures that was built by the K\*Grid. Although it will take three years to complete the environments, test service of the environments will start by the beginning of 2006.

Title	Organization	Area
Development of molecular simulation e-Science research environment and e-Glycoconjugates	Konkuk University	BT, NT
Development of e-Science Environment for HG2C based on service oriented architecture	Soongsil University	BT
Construction of numerical wind tunnel on the e-Science infrastructure	Seoul National University	Aerospace
Establishment of e-Science environment using the high voltage electron microscope	KBSI	Equipment control
Construction of e-Science environment for weather information system	Pukyong University	Meteorology

Table 2. Applications of Korea e-Science Project

### e-Science Common Software

As part of the Korea e-Science Project, workflow, visualization, and user portals are the main software areas of focus. These are intended to be made as general as possible, so they can be used in other applications projects (Table 1) and among other related communities. Extracting common components from various areas of applications is not expected to be an easy task. We start from a specific field of aerospace, discuss with area application developers to extract commonly used components, and define common application support software. Naturally, it will be extended to other application areas to define and refine common application support software.

# High Performance Computing in South Africa: Computing in Support of African Development

## 1. Introduction

In his 2002 State of the Nation address, President Thabo Mbeki of South Africa singled out Information and Communication Technology (ICT) as “a critical and pervasive element in economic development,” and recommended the establishment of an “ICT University.” The National Research and Development Strategy of South Africa had earlier also clearly identified ICT as one of the key technology platforms of the modern age, and one which has a central place in initiatives aimed at promoting development in South Africa.

The vision presented by President Mbeki has taken concrete form in the establishment of the Meraka Institute, the purpose of which is to facilitate national economic and social development through human resource development and needs-based research and innovation, leading in turn to products, expertise and services related to Information and Communication Technologies (ICT).

The Centre for High Performance Computing (CHPC)<sup>1</sup> is a component of the Meraka Institute. This article describes the objectives and structure of the CHPC and the progress that has been made to date in the establishment of this facility.

## 2. Background

South Africa is currently in the throes of expanding its scientific research and innovation base and is at the same time identifying focal directions, many of which have a direct link to social and economic development. While the National R&D Strategy sets the framework, there was a recognition that an ICT strategy was needed to chart a comprehensive national approach to ICT R&D in order to maximise its potential economic contribution. Through a co-ordinated national approach, a country like South Africa could not only develop the critical mass to boost its own national development, but also achieve international competitiveness in identified focal areas.

The overall purpose of the national ICT Strategy is to create an enabling environment for the advancement of ICT R&D and Innovation in identified domains. Computational Science and High Performance Computing are two of these. This stems from the firm recognition that access to high performance computing facilities is of central importance to the success of the technology missions identified in the National R&D Strategy. Key examples in this regard are Biotechnology, particularly with reference to research into the major infectious diseases such as HIV/AIDS and tuberculosis, advanced manufacturing technology (e.g., computational simulations of design and manufacturing processes, and computational materials design), technologies to utilise and protect our natural resources and ensure food security (e.g., climate systems analysis and disaster forecasting), and technology for poverty reduction (e.g., behavioural modelling in social research; financial management; HPC in SMEs). Similarly, a number of science missions were identified in the R&D Strategy as standing to benefit from the establishment of an HPC; examples are the Square Kilometre Array (SKA), the National Bioinformatics Network (NBN) and Global Earth Observing System of Systems (GEOSS). High Performance Computing is therefore clearly perceived, in relevant national strategic plans, to be a platform for scientific and technological innovation through which the national R&D strategy can be accelerated. The

**Rob Adam**

Director General's Office - Department of Science and Technology, Pretoria

**Cheryl de la Rey**

Deputy Vice-Chancellor's Office, Research & Innovation - University of Cape Town

**Kevin J. Naidoo**

Computational Chemistry, Department of Chemistry - University of Cape Town

**Daya Reddy**

Centre for Research in Computational & Applied Mechanics - University of Cape Town

---

<sup>1</sup> <http://www.chpc.org.za/>

dual impact of such a platform will be increased global competitiveness and improved local quality of life.

Funding for three years (2006-2008) has been secured for the high performance computing initiative. In addition, parallel investment in a South African National Research Network (SANReN), intended to provide high bandwidth connectivity for South African researchers, has been planned.

### 3. An African Renaissance in Technology and Development

The developments within South Africa are aligned with initiatives to stimulate research, development and technology across the African continent. A 'Plan for Collective Action' was adopted by African Ministers of Science and Technology in Dakar in November 2005, in a meeting organized jointly by New Partnership for Africa's Development (Nepad)<sup>2</sup> and the African Union (AU). This Plan was developed 'bottom-up' by engaging in consultations with scientists and institutions cross all five regions of the continent. It lays out programmatic initiatives and projects that are crucial to enable Africa to mobilize and strengthen its capacities to engage effectively in scientific and technological development. The Plan contains concrete actions that will build the continent's research base and stimulate innovations to fight poverty, increase economic competitiveness and promote human development in general. The Plan complements a series of AU and NEPAD programmes for such areas as agriculture, environment, infrastructure, industrialization, education and energy.

<sup>2</sup> <http://www.nepad.org/>

The three conceptual pillars of the 'Plan for Collective Action' are capacity building, knowledge production, and technological innovation. The Plan has twelve sub-programmes based on specific content areas, one of which is Information and Communications Technology. The ICT sub-programme will aim at establishing a continental research network on ICTs. It will bring together leading universities and research centres to design and implement projects that generate software and use with African content. Its specific goals will be to:

- stimulate technical change and innovation in ICTs
- build skills in local software research and development; and
- build knowledge of Open Source Software and promote its application in education, health and conduct of science.

Currently, a significant retarding factor is the exorbitant price of bandwidth on the African continent. Fortunately steps are now being taken to address this, with particular attention being given to reasonably priced connections to Europe and from there to other continents. Multinational negotiations regarding the laying of a cable up the east coast of Africa (the so-called Eassy cable) are far advanced.

### 4. The ICT Roadmap and the Meraka Institute<sup>3</sup>

<sup>3</sup> <http://www.meraka.org.za/>

Following President Mbeki's directive, the Meraka Institute was launched in May 2005. This is a public/private partnership seeking to promote co-operation between universities, industry and government on ICT learning, research, development and innovation informed by practical, needs-based challenges. The mandate of the Institute, which has been established as a national research centre within the Council for Scientific and Industrial Research, is to:

## High Performance Computing in South Africa: Computing in Support of African Development

- undertake world-class, needs-based basic research in the ICT field leading to development and innovation to the benefit of South Africa and the region.
- develop ICT knowledge workers with sound qualifications.
- establish SA as a highly competent international ICT player.
- attract leading ICT knowledge workers from various parts of the world.
- be the champion, voice, parent and mentor of an emergent South African ICT industry that is regionally relevant and globally competitive.

The Meraka Institute is guided by the fundamental principle that people are the prime basis for success in this knowledge intensive area. To date a number of areas of competency have been earmarked for inclusion in the Meraka Institute such as ICT for Disability, Human Language Technology, and an Open Source Centre. The CHPC is a major division within the Meraka Institute.

### 5. Centre for High Performance Computing (CHPC)

Global trends in the development of CHPCs have given strong impetus to plans to establish a CHPC in South Africa. The CHPC will function as a major national innovation platform, which is set to deliver a significant return on investment for the country, by

- stimulating and channelling scientific and technological innovation for economic development,
- driving the development of highly skilled human ICT capacity for transformation,
- harnessing the application of HPC for a positive social impact, and
- promoting the industrial exploitation of HPC and enabling local, export-driven industries.

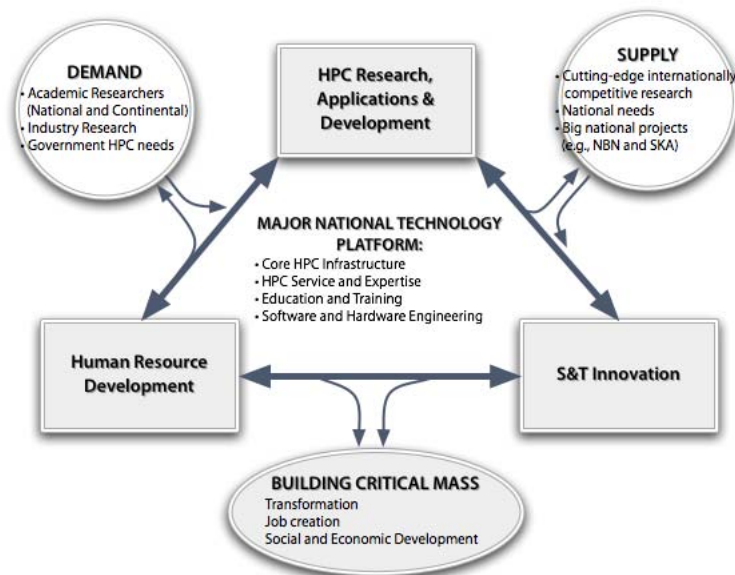

Figure 1. Core business concept of the CHPC

The core CHPC facility will be established in Cape Town, with the University of Cape Town designated as its formal host. The considerable existing strengths in scientific computing at various research institutes in South Africa form a large pool of expertise on which the CHPC will be based. Indeed, planning for the establishment of a CHPC began in Western Cape universities with a group of researchers in areas such as computational chemistry, grid computing in theoretical physics, climate modelling, bioinformatics, computational mechanics, radar signal processing and machine vision. Since assuming national proportions, the pool of expertise in scientific computing and HPC has been expanded, for example to include groups in computational physics at universities in Limpopo and Kwazulu-Natal provinces.

To ensure the development of expertise in a truly national fashion and to mitigate the drawbacks of a centrally located national facility, it is planned to establish regional nodes at a number of centres in South Africa. Far from being clones of the central CHPC, these will typically comprise small clusters, with a capacity of not greater than 1/20 of that of the parent facility, which will permit at a local level the initiation of research projects with an HPC dimension, as well as facilitating education and training in HPC. Access to the main CHPC is nevertheless a central plank in the planning, and regional centres will simultaneously have remote access to the central facility.

#### **National and International bandwidth**

Although the CHPC will provide an HPC environment that is fully functional as a stand-alone unit, connectivity of the national research institutions to the CHPC, as well as international connectivity to global networks, will have a significant impact on its role as a national resource and ease of access, as well as its reputation as a global player in the field of HPC. The CHPC will require bandwidth of at least 10Mb/s for national, and at least 155Mb/s for international, connectivity. The high cost of bandwidth is seen as a significant regulatory constraint, which currently inhibits the development of particularly networked high performance computing.

It is hoped that national high-bandwidth connectivity between CHPC member institutions across the country can be realised through the government's SANReN (South African National Research Network) initiative. The CHPC will also strive to provide South African researchers with the necessary international connectivity to participate in, benefit from, and contribute to global research activities. An agreement or partnership with Telkom, the national telecommunications company, leading to a donation (or at least an affordable supply) of the required national and international connectivity, will be negotiated.

#### **6. Progress to date and the way ahead**

Funding, at this stage largely from government, has been secured for the establishment of the central physical facility together with the appointment of scientific and technical staff by mid-2006. This major milestone has been preceded by a period of intensive planning extending over more than two years, in which stakeholders such as senior representatives of universities, the research community, relevant industries, and members of national government departments have worked to construct a common vision, strategy, and plan for operationalisation. In this regard, a key advisory role has been played by international colleagues with expertise in the establishment of HPCs. Linkages with similar facilities in developing countries such as Brazil and India are seen as essential to the success of the South African project, given this country's largely developing economy. And in this regard discussions have been held with CDAC in India with a view to establishing a relationship similar to that envisaged with LNCC in Brazil.



---

## High Performance Computing in South Africa: Computing in Support of African Development

A key objective will be that of identifying projects that will be supported through the CHPC. These will be identified through a dual process of solicitation of proposals on the one hand and identification of project areas, typically of national importance, on the other, which are deemed to be appropriate for location in the CHPC. Project areas that are of interest include those in materials modelling and minerals processing and computational fluid dynamics with potential impact on mining and materials-related industries; bioinformatics and medical imaging technologies with impact on the health and pharmaceutical sector; geophysics with impact on the oil exploration industry; computational chemistry, drug discovery and design, HIV/AIDS research, molecular modelling to improve process mining; climate systems modelling, which can be used to study climate change and for disaster forecasting; radio-astronomy and astrophysics with particular reference to the SKA project; image and visualisation technologies which impact the film making and tourism industries; and defence applications such as radar detection and advanced weaponry development.

In this millennium we will see the use of computers become critical to problems as diverse as drug design to combat diseases malaria and HIV/AIDS through the development of models for predicting drought and preventing crop failures. High performance computing is now being positioned at the centre of innovative technologies. The impact of design through scientific computing on economies driven by innovation will be significant.

The creation of a national Centre for High Performance Computing will permit South African scientists and engineers to be active at the cutting edge of their respective research disciplines within a vibrant intellectual atmosphere. The benefits of the linkage between research and innovation that is enabled through the CHPC will be felt not only in university laboratories but throughout the wider South African economy. The building of a critical mass in state-of-the-art high-performance computing equipment as well as high-level scientific computing expertise in an intellectual common space will be central to achieving the goal of making the African Renaissance a reality.

---

# Taiwan's Cyberinfrastructure for Knowledge Innovation

## Introduction

The Knowledge Innovation National Grid (KING) project (Figure 1) began as an initiative under the "Challenge 2008" program, a comprehensive six-year National Development Plan formulated by the Taiwan government in 2002. The objective of the KING project (2003-2006) is to deploy a Grid infrastructure and conduct innovative pilot applications. KING's twin project, the TaiWan Advanced Research and Education Network (TWAREN, 2003-2007) (Figure 2), is a world-class, island-wide, next-generation research and education network. The KING and TWAREN initiatives form the kernel of Taiwan's Cyberinfrastructure and provide an advanced and collaborative environment to our national research, government, and industrial communities. In the first stage of the project (2003-2006), we will deploy the necessary Grid resources and develop the required support technologies. We will then launch our Grid services beginning 2007.

Whey-Fone Tsai  
Fang Pang Lin  
Weicheng Huang  
Steven Shiau  
Ming Hsiao Lee  
Alex Wu  
John Clegg

National Center for High-Performance  
Computing, Taiwan

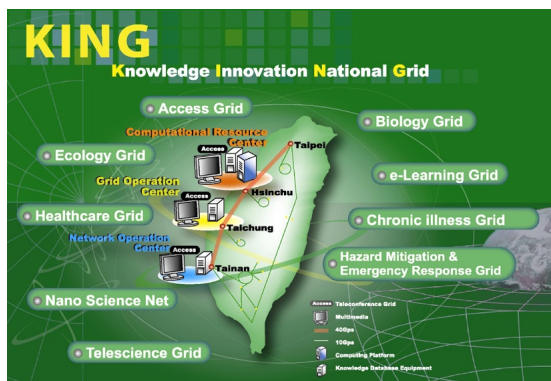

Figure 1. The Application-Driven Project, KING

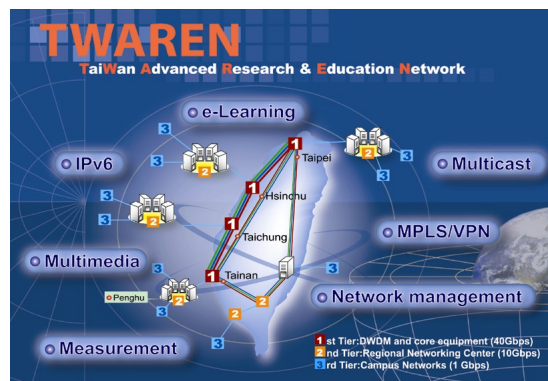

Figure 2. The TWAREN Network

## Cyberinfrastructure for Science and Engineering

The NCHC is the only national-level center in Taiwan dedicated to high-performance computing and networking research and services. The NCHC is also responsible for Taiwan's Cyberinfrastructure plan. Taiwan's Cyberinfrastructure plan was developed considering how to conduct successful applications and innovations (Figure 3). The term Cyber-resource refers to core HPC resources such as high-performance computing, high-end networking, and data storage. Cyber-technology includes technologies such as real-time communication, Sensor Network, and advanced visualization. The NCHC integrates Cyber-resources and Cyber-technologies to create Cyber-environments that ensure scientists and engineers can easily access these resources and technologies. Moreover, the Cyber-environment integrates distributed computing and data storage resources into computing Grid and data Grid to enable information integration and resource sharing. The Cyber-resource, together with Cyber-technology, attempts to build a comprehensive environment to meet users' demands for intensive and pervasive computing. International standards of quality management must be met if the Cyber-environment is to guarantee a high quality service. The Grid operation center is the key component of the NCHC's Cyber-operation. The Grid operation center encompasses a Grid monitoring system, emergency response system, Grid service system, and Grid operation system. The success of

## Taiwan's Cyberinfrastructure for Knowledge Innovation

the Cyberinfrastructure can be measured by observing the users' performance. The four categories of innovation supported by Cyber-innovation are 1) large-scale simulation, 2) human-life related Grids applications, 3) community alliances and, 4) international collaborations. The Cyberinfrastructure plan may be modified in accordance with users' needs and technology advancement.

### Cyber-Environment

In order to serve industrial R&D as well as academia, three of TWAREN's four core nodes are located within Taiwan's Science Parks. Eleven regional centers (GigaPoPs), linked to the backbone as 10 Gbps Metropolitan Area Networks (MANs), serve to bring Taiwan's major institutions of higher education and research onto the network. TWAREN provides many services not available from commodity networks such as IPv6, multicast, MPLS/VPN, VOIP, e-learning, and multimedia.

The NCHC's Cyber-resources are geographically distributed across Taiwan at three different resource centers. The Hsinchu Business Unit, located in northern Taiwan, houses the NCHC's supercomputers, software library, and scientific databases. The soon-to-be-completed Taichung Business Unit, located in central Taiwan, will be the NCHC's Knowledge Management Center. It will be a Peta-scale data storage service center and serve as NCHC's Grid Operation Center as well. The Tainan Business Unit, located in southern Taiwan, serves as the NCHC's Network Operation Center (NOC). These three resource centers are linked to each other via the TWAREN network, thus allowing for the integration of all of the NCHC's computing and data Grid resources.

The Cyber-environment's major task is to build a Cyberinfrastructure on a scale that has never before been seen in Taiwan. The basic infrastructure includes a high-end computing facility and a 100 TB level storage system running on top of 10-Gbps level of Wide Area Network (WAN). Although these developments are not quite as impressive when compared to those of worldwide Grid activities, they are indeed the largest resources in Taiwan.

The build-up of the basic infrastructure is only the first step. We must also focus on how to provide stable, secure, and scalable services to our scientific computing community. Over the past two years, we have devoted the majority of our efforts to the construction of a generic computing Grid environment. This environment was built to help hide the complexity of Grid computing from the end users and to provide easy access to the backend computing facilities and storage. The fundamental concept of building such a "generic" computing Grid is to provide a base line for the development of an application-specific Grid. Application developers can easily modify this generic solution to develop their own customized computing Grid if common features are already built into it.

The generic computing Grid seems to have adopted the worldwide standard of Grid middleware, however, the bridge between the middleware and the user is not standardized. The Grid must provide special features that traditional scientific computing does not. The user should be able to simply "fire and forget." In other words, the user should be able to submit a job and then let the system take care of execution and notification of the results.

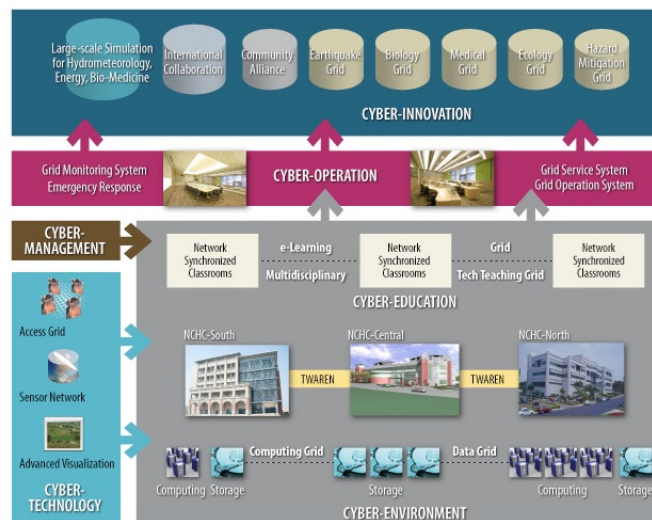

Figure 3. The Cyberinfrastructure Map

The ultimate goal of Grid computing is to provide seamless and consistent “plug and play”-style computing to its users. In order to realize this, we must enhance Grid’s middleware and learn to better manage its infrastructure. Also, middleware must be adopted and integrated while new features are added. This will further reduce the barrier between the Grid and its users. Various tasks such as automation, resource brokerage, meta-scheduling, and advanced reservations can be carried out over the Grid system while, at the same time, hiding the Grid’s complexity.

The large-scale problems of the future will be much greater than those of today. In the future, many modern technologies and applications will become routine and will be integrated into a much larger system that is able to solve much more complicated problems. The modern super-computer will become no more than a simple piece of hardware that will not require further development. On the other hand, the Cyber-environment will demand intensive development in order for it to solve the large-scale problems of tomorrow. The primary tasks demanding our attention in the future will be to provide the user with a satisfying Grid experience, to further hide the complexity of the Grid computing environment and its backend facilities and, finally, to achieve the goal that Grid computing set out to achieve originally. It will not be enough to simply implement solutions that meet the research demand. We must truly transform the way research is done and inspire new means of R&D. The Cyber-environment will make all of this a reality.

## **Cyber-Technologies**

Technologies such as real-time communication, remote data gathering sensors, and advanced visualization have been developed to support the Cyber-environment. Access Grid (AG) technology is used for real-time group-to-group communication and interactions across the Grid. The NCHC has been actively developing AG-enhancing applications since 2003. These developments integrate modern video codecs such as MPEG4 and H.264 into the video (vic) element of AG. This has resulted in a richer and high quality video conference. The NCHC’s AG team is committed to developing additional functionality that can contribute to future versions of ANL AG.

The NCHC has designed a sensor network embedded system and collaborated with various hardware suppliers to deploy the necessary resources to collect field data for applications such as Ecology and Flood Mitigation. The system is remotely controlled via IPv6 and IPv4. All the video, audio and measurement data obtained from data loggers are collected real-time and archived so that it can be analyzed by experts anytime, anywhere.

The NCHC’s Advanced Visualization team has developed distributed rendering packages such as Image-based Visualization Interface (IvI), IvIsee, IvI4MIE, and IvItune. The NCHC also developed a Multi-Method Streaming Access Server for mono and stereo display and a 4x3 tiled display wall (TDW) that utilizes 24 projectors. The NCHC’s TDW is powered by a 13-node cluster. Real-time video/audio streaming, TV programs, and high-definition movies can be shown in the TDW environment. This same technology has been used to construct a LCD-based TDW system.

## Taiwan's Cyberinfrastructure for Knowledge Innovation

### Cyber-Education

The NCHC has worked diligently to bring the Cyber-environment into the classroom. As an example, the NCHC used the Access Grid to conduct high-performance computing distant learning courses. The network-synchronized classrooms at NCHC's three business units have been equipped with AG capabilities that include recording, broadcasting, and auto recovery. In addition to the Cyber-education project at the NCHC, there are about 30 primary schools, high schools, and colleges (approximate 100 sites) using the distant learning system to conduct classes. The system has also been selected as the official system for the national multidisciplinary-technology teaching platform. This platform includes instruction on nano technology, optical electronics, and bio-medical technology. About 60 universities will join this project by year's end. The NCHC also provides real-time simulation and collaborative visualization for the multidisciplinary-technology teaching platform.

### Cyber-Operation

The NCHC-developed Grid infrastructure will become fully operational in 2007. It will be deployed and managed from the NCHC's Grid Operation Center located in central Taiwan. The Grid Operation Center will be responsible for monitoring the operation of the Grid Cyberinfrastructure as a whole. These responsibilities include devising and managing servers, networks, and procedures that optimize the Grid's operation and working with Local Support Societies to provide them the best services.

The Grid Operation System is constructed with a layered architecture that includes the facility layer, the function module layer, the solution module layer, the application module layer, and the interface and media layer. It provides its users with a dynamic and total service solution. It also manages the availability, scalability, quality, and security of the service.

An efficient Grid monitoring system has been developed to help maintain the stable availability and quality of service. It utilizes web and mobile measurements, network, systems, and Grid resources monitoring to ensure that the users' services are always available and running at peak performance.

The Emergency Response System is a software platform that utilizes GIS, video conference systems, and sensor net systems to centralize and distribute necessary data and information for decision-making in emergency situations. The Emergency Response System is housed in specially prepared rooms that are equipped with display walls and video conference facilities. These amenities enable the user to monitor any site in Taiwan in visually-rich 3D. These facilities also help decision makers make the right decision when emergency situations such as fires, flooding, typhoons, and other emergency situations take place.

The Grid Service System is designed based on the users' viewpoint. It meets those expectations internally and externally and automatically creates management tools to verify that those expectations are being met. This Services Module is a dynamic application protocol framework. Local Grid societies are able to choose and combine the kinds of services they need and use them in an integrated Grid environment.



## Cyber-Innovation

The Cyberinfrastructure combines KING and TWAREN to provide for large-scale resource sharing. This, in turn, enables the synthesis of hypothesis and data driven applications. Such a synthesis will result in a new method of education, research, and collaboration and will ultimately lead to innovation in a broader sense or, in other words, Cyber-innovation.

## Large-Scale Simulations

The Grid was initially developed to enable large-scale simulations that couldn't be computed using a single supercomputer. The Cyberinfrastructure of KING and TWAREN will focus on large-scale simulation research in the fields of Hydrometeorology, Energy, and Bio-Medical research. National and international experts from academia also join the NCHC research team in the development of this field.

## Grid Applications

The resource-sharing applications devised for the Cyber-innovation encompasses education-based projects such as E-learning Grid and Multi-disciplinary e-Teaching Platform. It also includes specific Life Science Grid-based projects such as Biology Grid, SARS Grid, Asthma Grid, and Eco Grid. It also includes engineering research in Hazard Mitigation projects such as Flood Mitigation Grid and Earthquake Engineering Grid. These applications are directly related to information collection, fusion, processing, and sharing. Table 1 illustrates the extent that Grid-based applications depend on Grid resources and supporting technologies. The utilization of a network is intrinsic to all applications. The incorporation of sensor networks is particularly prominent in many applications. It allows for the automation of workflow from direct observation and/or raw data collection to simulation.

The NCHC's Grid-based achievements include SARS Grid, Asthma and Lung Cancer Grids, E-learning, Global Lakes Environmental Observational Networks (GLEON), Coral Reefs Environmental Observational Networks (CREON), and the Bio Grid-based 3D confocal images of the *Drosophila* fruit fly brain.

Application	Grid Resources			Supporting Technologies		
	Network	Computing	Data Storage	Access Grid	Sensor Network	Visualization VR
E-Learn Grid	S	W	S	S	W	M
Multidisciplinary e-Teaching Platform	S	S	S	S	S	S
Ecology Grid: GLEON/	S	M	S	W	S	W
Flood Mitigation Grid	S	S	S	S	S	S
Asthma Grid	S	W	S	W	S	W
SARS Grid	S	W	M	S	S	M
Earthquake Engineering Grid	S	S	S	M	S	M
Biology Grid	S	M	S	W	W	S

Table 1. The Weighting of Grid Resources and Supporting Technologies Used In Various Grid Applications

---

## Taiwan's Cyberinfrastructure for Knowledge Innovation

### Community Alliances

Resource sharing also implies the physical network that connects the computing resources as well as the "people" network needed to develop specific application domains. Similar large-scale international Grid projects such as the USA's TeraGrid project and the UK's e-Science program also incorporate this "people" network. Each of KING's applications has a specific community alliance attached to it. As an example, Flood Mitigation Grid is supported by Taiwan's Water Resource Agency (WRA). Flood Mitigation Grid is also utilized by Taiwan's water management offices, professors, researchers, and engineers. In another example, Chang Gung University and its medical centers support the NCHC's Medical Grid project in their effort to better understand medical information.

### International Collaborations

The TWAREN network is based on the Internet Protocol (IP). The IP and higher layer Grid middleware are based on open standards. This allows for the transparent sharing of resources at a local, regional, and global level. In recent years, international collaboration has become commonplace, however, newly developed models of international collaboration must also evolve to meet new needs. International organizations such as the Pacific Rim Applications and Grid Middleware Assembly (PRAGMA), Asia Pacific Grid (ApGrid), and the Global Grid Forum (GGF) have been established to meet these needs. The NCHC is an active member in all of these organizations and follows their development very closely. All resources and application developments are shared extensively within these organizations. The NCHC led the combat against SARS in 2003. The NCHC also hosted the 5th PRAGMA later that same year. The NCHC is also active in the development of a new ecological research organization established to monitor global lakes and coral reefs via sensor networks.

### Conclusion

Over the last three years, the NCHC has deployed a robust and comprehensive Cyberinfrastructure plan for Taiwan. The Cyberinfrastructure's distributed and shared resources, including high-end networking, computing, and data storage, are fully operational. The Cyberinfrastructure's supporting technologies are also completely developed and have been utilized to create many useful and life-enhancing applications. Through its pilot applications, the NCHC has shown great innovation and leadership in human life-related Grids. Beginning 2007, the NCHC will provide complete Grid operation service from its central Taiwan Business Unit. Also beginning 2007, the NCHC will evolve its Cyberinfrastructure to service local business and industry in addition to academia.

---

### Relevant Links

KING - <http://webgis.nchc.org.tw/kingnew/site.html>  
NCHC web site - <http://www.nchc.org.tw/en/>  
NCHC Access Grid - <http://twag.nchc.org.tw>  
NCHC Sensor Network - <http://sensor.nchc.org.tw>  
NCHC TDW - <http://tdw.nchc.org.tw>  
TWAREN - <http://www.twaren.net/>

# PRAGMA: Example of Grass-Roots Grid Promoting Collaborative e-Science Teams

## Introduction

Science is a global enterprise. Its conduct transcends geographic, discipline, and educational levels. The routine ability to work with experts around the world, to use resources distributed in space across international boundaries, and to share and integrate different types of data, knowledge and technology is becoming more realistic. It is the development and deployment of compatible cyberinfrastructures (a.k.a Grid) that link together computers, data stores, and observational equipment via networks and middleware that form the operative IT backbone of international science teams. While, large community projects exist that exploit the Grid (e.g. Large Hadron Collider)<sup>1</sup>, international collaboration can and most likely will take place at scales of smaller teams. For example, a multidisciplinary, distributed team of researchers from the University of Zurich, the University of California San Diego, and Monash University in Australia are synthesizing application and grid middleware, using distributed computational resources from the PRAGMA testbed<sup>2</sup>, to gain understanding of complex biochemical reactions than can impact the design of new drugs<sup>3 4 5 5a 6</sup>. This example and others<sup>7 8 9</sup> demonstrate the value and potential of working with the emerging cyberinfrastructure. Yet, significant effort was required to bring these tools, people and resources together. The current challenge for the Grid community is to make this potential and demonstration a reality, on a routine basis.

Peter Arzberger

University of California, San Diego

Philip Papadopoulos

San Diego Supercomputer Center  
University of California, San Diego

## Pacific Rim Application and Grid Middleware Assembly (PRAGMA)

Established in 2002, the Pacific Rim Application and Grid Middleware Assembly<sup>10</sup> is an open organization whose focus is how to practically create, support and sustain international science and technology collaborations. Specific experiments are postulated, candidate technologies and people are identified to support these experiments, evaluation is performed in our trans-Pacific routine-use laboratory, and successful solutions are integrated into country-specific software stacks or Global Grid Forum<sup>11</sup> standards. The group harnesses the ingenuity of more than 100 individuals from 25 institutions to create and sustain these long-term activities. PRAGMA plays a critical role as an international conduit for personal interactions, ideas, information, and grid technology. Our multi-faceted framework for collaboration catalyzes and enables new activities because of a culture of openness to new ideas. Our pragmatic approach has led to new scientific insights<sup>3</sup>, enhanced technology<sup>12 13 14</sup>, and a fundamental sharing of experiences manifest in our routine-use laboratory.

<sup>1</sup> Large Hadron Collider - <http://lhcb.web.cern.ch/lhc/>

<sup>2</sup> Baldrige, K.K., Sudholt, W., Greenberg, J.P., Amoreira, C., Potier, Y., Altintas, I., Birnbaum, A., Abramson, D., Enticott, C., Slavisa, G. Cluster and Grid Infrastructure for Computational Chemistry and Biochemistry. In *Parallel Computing for Bioinformatics* (Invited Book Chapter), A. Y. Zomaya (Ed.), John Wiley & Sons, 2005, In press.

<sup>3</sup> Sudholt, W., Baldrige, K. K., Abramson, D., Enticott, C., Garic, S. Parameter Scan of an Effective Group Difference Pseudopotential Using Grid Computing. *New Generation Computing*, Vol.22 No 2 (Special Feature Grid Systems for Life Sciences), February 2004.

<sup>4</sup> Sudholt, W., Baldrige, K., Abramson, D., Enticott, C., Garic, S., Applying Grid Computing to the Parameter Sweep of a Group Difference Potential, *The International Conference on Computational Sciences, ICCSO4, Krakow Poland, June 6 - 9, 2004.*

<sup>5</sup> The chemistry codes are GAMESS, a community code for quantum mechanics calculations, APBS - Adaptive Poisson Boltzmann Solver (apbs.

[sourceforge.net/](http://sourceforge.net/)), with an integrated framework for connecting grid resources, GEMSTONE<sup>5a</sup>, with parameter sweeps middleware (Nimrod) over a grid.

<sup>5a</sup> Baldrige, K. K., Bhatia, K., Greenberg, J.P., Stearn, B., Mock, S., Sudholt, W., Krishnan, S., Bowne, A., Amoreira, C., Potier, Y. GEMSTONE: Grid-Enabled Molecular Science through Online Networked Environments. Invited paper: LSGRID Proceedings, 2005, in press

<sup>6</sup> Sudholt, W., Baldrige, K., Abramson, D., Enticott, C., Garic, S., Kondric, C., Nguyen, D. Application of Grid Computing to Parameter Sweeps and Optimizations in Molecular Modeling. *Future Generation Computer Systems* (Invited), 2005, 21, 27-35. <sup>2</sup> Baldrige, K.K., Sudholt, W., Greenberg, J.P., Amoreira, C., Potier, Y., Altintas, I., Birnbaum, A.

<sup>7</sup> Abramson, D., Lynch, A., Takemiya, H., Tanimura, Y., Date, S., Nakamura, H., Jeong, K., Lee, H., Wang, C., Shih, H.L., Molina, T., Baldrige, K., Li, W., Arzberger, P. Deploying Scientific Application on the PRAGMA Grid Testbed: Ways, Means and Lessons. Accepted CGrid 2006

<sup>8</sup> Hey, A., Trefethen, A. Cyberinfrastructure for e-Science, *Science* 2005 308: 817-821.

<sup>9</sup> A 21st Century National Team Science Infrastructure - <http://www.calit2.net/newsroom/release.php?id=660>

<sup>10</sup> Pacific Rim Application and Grid Middleware Assembly - <http://www.pragma-grid.net/>

<sup>11</sup> Global Grid Forum - <http://www.ggf.org/>

<sup>12</sup> Telescience Portal - <http://telescience.ucsd.edu/>

<sup>13</sup> Nimrod - <http://www.csse.monash.edu.au/~davida/nimrod/>

<sup>14</sup> Gfarm - <http://datafarm.apgrid.org/>, a global parallel file system developed by AIST in collection with KEK, University of Tokyo and Titech.

## PRAGMA: Example of Grass-Roots Grid Promoting Collaborative e-Science Teams

PRAGMA began with the following observations: global science communities were emerging in increasing numbers; grid software had entered its second phase of implementation; and international networks were expanding rapidly in capacity as fundamental high-speed enablers for data and video communication. But, the integration and productive use of these potential tools was “out of reach” to many scientists. To address the issue of making this technology routinely accessible, a founding set of Pacific Rim Institutions began to work together to share ideas, challenges, software, and possible end-to-end solutions.

Our common-sense approach begins with prospective collaborative science-driven projects (like whole genome annotation, quantum chemistry dynamics, Australian Savannah wildfire simulation, and remote control of large electron microscopes coupled with 3D tomographic reconstruction) so that both people and candidate technologies can be identified to address the scientific needs. Identification is through people-to-people networking, progressively more sophisticated demonstrations, tutorials on software components (e.g. gFarm, MOGAS<sup>15</sup>, Nimrod, Rocks<sup>16</sup>, Ninf-G<sup>17</sup> and others) and a consistent face-to-face workshop schedule. When enough ingredients are available to start down the pathway of using the Grid, integrating software to be grid-aware, and/or sharing data, then software is instanced onto our routine-use laboratory. This lab (described in more detail below with its evolution and management challenge described in<sup>18</sup>) is where technologists from multiple organizations work together to provide a baseline infrastructure for evaluation. Successful science projects can move to larger resource pools if needed. The entire end-to-end process is possible because of an active international steering committee that continually focuses the group’s multiple efforts for tangible results. Below we describe and illustrate these key components of PRAGMA, together with software distribution and community building.

### Collaborative Science-driven Teams

PRAGMA brings multidisciplinary, multi-institutional teams together, driven by application needs. In addition to the computational chemistry application described above, another team of researchers from the US, Japan, China, and Singapore, integrated a protein annotation pipeline (iGAP<sup>19</sup>) developed at UCSD, a distributed file system (Gfarm<sup>20</sup>) developed at the National Institute for Advanced Industrial Science and Technology (AIST), and a metascheduler (CSF) being extended by researchers at Jilin University in China to schedule iGAP testing<sup>21</sup>. This software/middleware synthesis effort has led to improvements of Gfarm. In particular, the metadata server design is changed to meet the requirements of high throughput file creation and registration. Automatic replication of data and deployment of applications to remote sites become fully supported for most common architectures<sup>7</sup>. Finally, a successful annotation of the bacteria, *Burkholderia mallei*, a known bioterrorism agent, has been conducted with this infrastructure and the PRAGMA testbed (the annotation will be publicly available pending publication of analysis results).

A final example integrates expertise of IPv6 networking at the Cybermedia Center of Osaka University, remote control of a microscope at UCSD, and use of a computational grid to build tomographic reconstructions of subcellular structures, and the development of visualization modules from the National Center of High-performance Computing (NCHC), to provide an enhanced suite of tools for researchers to use<sup>22</sup>. Not only did the team benefit, but each group did as well. UCSD researchers were able to better access the machine in Japan and distributed compute resources at the three sites. Osaka researchers were able to control the machines and make codes available to their users, and NCHC colleagues were able to take the concept and

<sup>15</sup> Multiple Organization Grid Accounting System - <http://www2.ntu.edu.sg/SCERN/Dec2004/art1.htm>, [http://pragma-goc.rocksclusters.org/softdepot/ntu\\_acct.html](http://pragma-goc.rocksclusters.org/softdepot/ntu_acct.html), <http://ntu-cg.ntu.edu.sg/pragma/index.jsp>

<sup>16</sup> NPACI Rocks - <http://www.rocksclusters.org/>

<sup>17</sup> NPACI Rocks - <http://www.rocksclusters.org/>

<sup>18</sup> Zheng, C., Abramson, D., Arzberger, P., Ayuub, S., Enticott, C., Garic, S., Katz, M., Kwak, J., Papadopoulos, P., Phatanapherom, S., Sriprayoosakul, S., Tanaka, Y., Tanimura, Y., Tatebe, O., Uthayopas, P. The PRAGMA Testbed: Building a Multi-Application International Grid 2005. CCGrid 2006 (submitted).

<sup>19</sup> Li, W.W., Byrnes, R.W., Hayes, J., Birnbaum, A., Reyes, V.M., Shahab, A., Mosley, C., Pekurovsky, D., Quinn, G.B., Shindyalov, I.N., Casanova, H., Ang, L., Berman, F., Arzberger, P.W., Miller, M.A., Bourne, P.E. The Encyclopedia of Life Project: Grid Software and Deployment. *New Generation Computing*, Vol.22 No 2 pp 127-136 (Special Feature Grid Systems for Life Sciences). February 2004. - <http://www.ohmsha.co.jp/ngc/ngc2202.htm>

<sup>20</sup> Tatebe, O., Ogawa, H., Kodama, Y., Kudoh, T., Sekiguchi, Matsuoka, S., Aida, K., Boku, T., Sato, M., Morita, Y., Kitatsujii, Y., Williams, J., Hicks, J., The Second Trans-Pacific Grid Datafarm Testbed and Experiments for SC2003, *Proceedings of 2004 International Symposium on Applications and the Internet - Workshops (SAINT 2004 Workshops)*, 26-30 January 2004, Tokyo, Japan

<sup>21</sup> Wei, X., Li, W. W., Tatebe, O., Xu, G., Liang, H., Ju, J. Implementing data aware scheduling in Gfarm using LSFTM scheduler plugin mechanism. *Proceedings of the 2005 International Conference on Grid Computing and Applications (GCA'05)*. Las Vegas. 2005. In press.

<sup>22</sup> Lee, D., Lin, A.W., Hutton, T., Akiyama, T., Shinji, S., Lin, F.P., Peltier, S., Ellisman, M.H. Global Telescence Featuring IPv6 at iGrid2002. *Future Generation of Computer Systems*, 19(6): 103139. 2003.

knowledge of remote control of a microscope and retarget the application to that of sensors in the environment, creating EcoGrid<sup>23</sup> in Taiwan.

Each of these international science and technology teams has shared technology and experience to significantly enhance their research agendas. The structure of PRAGMA, with its culture of openness to new ideas and technologies coupled with a recurring series of focused workshops<sup>24</sup>, provided the essential glue for these teams. Each of these accomplishments has resulted in ongoing collaborations that now span years.

### Routine Use Grids

These and other examples<sup>7</sup> have driven the use of PRAGMA's evolving grass-root grid testbed. The overall goal of the PRAGMA testbed is to provide a stable platform to allow these and other application/middleware codes to be tested, and to understand how to make applications run on a routine basis without the superhuman efforts that many of these examples currently require.

The current testbed consists of resources and participants from 19 institutions from five continents and 13 countries. It is an instantiation of a useful, interoperable, and consistently available grid system that is neither dedicated to the needs of a single science domain nor funded by a single national agency. This testbed is heterogeneous in equipment and connectivity (bandwidth as well as persistence) between machines, reflecting both funding realities and the future global cyber-infrastructure.

The testbed has been grown using a minimum set of requirements. The initial software stack comprised of Globus plus local scheduling software. Additional middleware is added based on the needs of the applications. For example, a remote procedure call middleware, Ninf-G developed at AIST, became part of the testbed since it was required by two applications being used in PRAGMA: one is a time dependent density functional theory calculation; the other a Quantum Mechanical / Molecular Dynamics (QM/MD) code<sup>7</sup>.

These routine use experiments have produced results through strong feedback between application and middleware developers. Codes have had to be improved to operate in a network environment where connections fail, in particular to be more fault tolerant. The testbed development is being driven by many application areas, allowing examination of different requirements. In addition, a richer monitoring set (SCMSWeb)<sup>25</sup> developed at Kasetsart University and accounting tools (MOGAS)<sup>26</sup> of the Nanyang Technological University were introduced to the testbed.

PRAGMA has demonstrated that these grids can be very useful to improve codes and to conduct meaningful and otherwise unachievable science.

### Multiway Software Dissemination

As software is tested in these real-world environments and used in multiple applications, ways of disseminating software is needed. In the case of Ninf-G, we have successfully developed a procedure that allowed it to be integrated into the US NMI software stack for version 8 and subsequent releases. This was the first instance of a non-US code being introduced into that stack. Another dissemination vehicle we are using is the Rocks Rolls mechanism (i.e. RPM packages configured for automatic (re)deployment to Rocks-based clusters). PRAGMA partners also released codes with changes, and Rocks was localized by the partners at the Korea Institute for

<sup>23</sup> EcoGrid - <http://ecogrid.nchc.org.tw/>

<sup>24</sup> Recent workshops were hosted by the PRAGMA members Bioinformatics Institution and the National Grid Office Singapore (May 2005), University of Hyderabad (October 2005). Future workshops will be hosted by University of Queensland and the Australian Partnership for Advanced Computing (March 2006), Osaka University (October 2006), National Electronics and Computer Technology Center and Kasetsart University (Spring 2007), National Center for Supercomputing Applications (Fall 2007), and NCHC (Spring 2008).

<sup>25</sup> Scalable Cluster Management System Web - <http://www.opensce.org/components/SCMSWeb/>

<sup>26</sup> Lee, B-S., Tang, M., Zhang, J., Soon, O.Y., Zheng, C., Arzberger, P. Analysis of Jobs on a Multi-Organizational Grid Test-bed. CCGrid 2006 (accepted).



## PRAGMA: Example of Grass-Roots Grid Promoting Collaborative e-Science Teams

Science and Technology Information (KISTI) to allow for easier access and use by the Korean Grid community<sup>27</sup>. And with broader dissemination comes broader use. In one case this led to a set of standards proposed in GGF for remote procedure calls<sup>28</sup>.

Finally, as the broader community produces new codes or standards, PRAGMA will adopt them. Examples include the CA from Naregi<sup>29</sup> or the PMA lead by AIST, which then are used by the broader PRAGMA community.

### Building a Community

PRAGMA itself focuses on a grass roots approach in an effort to enable new communities to form and assemble expertise not available at any single institution. Some global issues require the ability to rapidly form international teams. Responses to epidemics such as SARS (PRAGMA played a crucial role in helping to pull together an international team to aid Taiwan in their efforts to combat the disease)<sup>30</sup> and emerging threats like Avian Flu often require teams to assemble in hours or days. Other groups with a small set of geographically dispersed experts simply do not have the personnel resources to independently build a complete cyberinfrastructure. In this model, PRAGMA has played a leading role in catalyzing GLEON<sup>31</sup>, the Global Lake Ecological Observatory Network, a grassroots network of limnologists, information technology experts, and engineers with a common goal of building a scalable, persistent network of lake ecology observatories. Data from these observatories will help this community to better understand key processes such as the effects of climate and land use change on lake function, the role of episodic events such as typhoons in resetting lake dynamics, and carbon cycling within lakes. These teams are, by nature and expertise, international in scope.

We have built a community by focusing on concrete projects to build trust and on an ongoing series of semi-annual working meetings. The meetings rotate among PRAGMA member sites to engage a broader group of researchers at each site and to allow the PRAGMA community to appreciate its members' cultural richness.

Students are an essential component of the PRAGMA community. Pacific Rim Undergraduate Experiences (PRIME)<sup>32</sup> provides UCSD undergraduate students summer research experiences at four PRAGMA sites; Osaka, Monash, NCHC, and the Computer Network Information Center of the Chinese Academy of Sciences (CNIC). The students conduct research and contribute to the infrastructure. Further, they have helped expand the collaborations between scientists at the institutions. In addition, the Japanese government has awarded Osaka University funds to create Pacific Rim International Universities (PRIUS), a program designed to improve education for graduate students interested in grid technology by supporting a series of activities, including exchanges. Both PRIME and PRIUS build on and enhance the PRAGMA community and would not exist without PRAGMA.

### Final Comments

PRAGMA is both a multifaceted organization and an experiment. It is open to institutions who wish to actively participate in projects and contribute and share resources, middleware, applications and expertise with other members. The value of the structure is that it allows for transfer of technology among institutions, allowing in some cases for rapid start ups by acquiring technology, and in other cases for user feedback on technologies that have been developed. The structure also allows for a transfer of technologies between disciplines where, for example,

<sup>27</sup> KROCK - <http://rocks.cluster.or.kr>

<sup>28</sup> Tanimura, Y., Ikegami, T., Nakada, H., Tanaka, Y., Sekiguchi, S., Proceedings of the Workshop on Grid Applications: from Early Adopters to Mainstream Users, GGF Documents, 2005.

<sup>29</sup> National Research Grid Initiative - [http://www.naregi.org/index\\_e.html](http://www.naregi.org/index_e.html)

<sup>30</sup> National Science Foundation FY2003 Performance Highlights (NSF-04-011) [See page "From the Director" and page 14] <http://www.nsf.gov/pubs/2004/nsf04011/>

<sup>31</sup> Global Lake Ecological Observatory Network - <http://gleon.org/>

<sup>32</sup> Pacific Rim Undergraduate Experiences - <http://prime.ucsd.edu/>

control of an instrument is being moved from neuroscience and a microscope to ecology and a sensor.

Collectively, we have built a human network that allows for new activities to begin. We have built a stable, persistent grass-roots grid testbed on which codes can be tested and science conducted. We have shared our experiences via publications and the improved codes via a variety of software dissemination vehicles, allowing the broader community to benefit. Finally, we have used the structure to build a legacy where researchers will work, collaborate, and educate internationally.

---

### **Acknowledgements**

Each of the authors would like to acknowledge support from NSF INT-0314015 for our participation in PRAGMA and for OCI 0505520, for integrating Ninf-G into the NMI stack. We also acknowledge NSF INT-0407508, Calit2 and GEON for their support of PRIME. We wish to thank NSF current and former program officers for their strong partnership and encouragement to “take advantage of the geographical location of San Diego, on the pacific rim” and build the community.

We also note that NSF funds helped leverage resources from PRAGMA partners and their funding agencies. Without partnership involvement, we would not exist.

Finally, we wish to acknowledge the support of NIH P41 RR08605 which supports tools for the biomedical community, the Betty and Gordon Moore Foundation for the launch of GLEON, and NSF NEON 0446802 for tools in GLEON.

**PUBLISHERS**

Fran Berman, Director of SDSC  
Thom Dunning, Director of NCSA

**EDITOR-IN-CHIEF**

Jack Dongarra, UTK/ORNL

**MANAGING EDITOR**

Terry Moore, UTK

**EDITORIAL BOARD**

Phil Andrews, SDSC  
Andrew Chien, UCSD  
Tom DeFanti, UIC  
Jack Dongarra, UTK/ORNL  
Jim Gray, MS  
Satoshi Matsuoka, TITech  
Radha Nandkumar, NCSA  
Phil Papadopoulos, SDSC  
Rob Pennington, NCSA  
Dan Reed, UNC  
Larry Smarr, UCSD  
Rick Stevens, ANL  
John Towns, NCSA

**CENTER SUPPORT**

Greg Lund, SDSC  
Karen Green, NCSA

**PRODUCTION EDITOR**

Scott Wells, UTK

**GRAPHIC DESIGNER**

David Rogers, UTK

# CTWatch QUARTERLY

ISSN 1555-9874

VOLUME 2 NUMBER 1 FEBRUARY 2006

## INTERNATIONAL CYBERINFRASTRUCTURE: ACTIVITIES AROUND THE GLOBE

GUEST EDITOR **RADHA NANDKUMAR**

AVAILABLE ON-LINE:  
[www.ctwatch.org/quarterly/](http://www.ctwatch.org/quarterly/)



E-MAIL:  
[quarterly@ctwatch.org](mailto:quarterly@ctwatch.org)



<http://icl.cs.utk.edu/>



<http://www.ncsa.uiuc.edu/>



<http://www.sdsc.edu/>

CTWatch Quarterly is a publication of the CyberInfrastructure Partnership (CIP).  
© 2006 NCSA/University of Illinois Board of Trustees  
© 2006 The Regents of the University of California